



COLD CLIMATE HOUSING RESEARCH CENTER

**CCHRC**



# The Alaska Consumer Guide to **HOME HEATING**

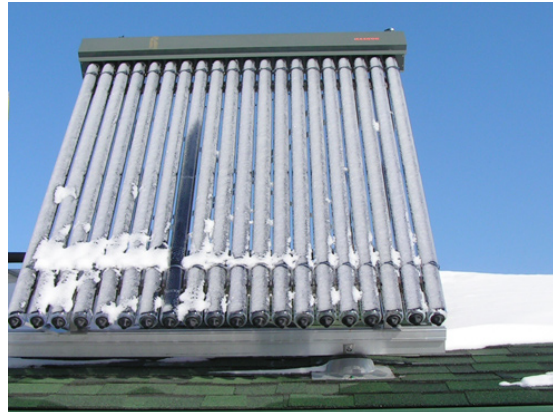

An introduction to safe, efficient,  
and cost-effective heating systems.





This document was funded by the Alaska Housing Finance Corporation, located in Anchorage, AK. It is the mission of AHFC to provide Alaskans access to safe, quality, affordable housing.

[www.ahfc.us](http://www.ahfc.us)



COLD CLIMATE HOUSING RESEARCH CENTER

**CCHRC**

This document was authored by the Cold Climate Housing Research Center, located in Fairbanks, AK. It is the mission of CCHRC to promote and advance the development of healthy, durable, and sustainable shelter for Alaskans and other circumpolar people.

[www.cchrc.org](http://www.cchrc.org)

The decision to purchase or upgrade a heating system depends on many factors including the availability of fuel, building specifics, costs, and personal preferences. This Consumer Guide presents information on several types of heating appliances, distribution systems, hot water heaters and controls. It does not constitute an endorsement or approval for any of these systems.

# TABLE OF CONTENTS



## Tools for Homeowners

What is a heating system?	p. 4
How safe is my heating system?	p. 5
How efficient is my heating system?	p. 6
How much will my heating system cost me?	p. 12
Is my heating system the correct size for my house?	p. 15
Should I replace my existing heating system?	p. 17
How do I choose a contractor?	p. 19

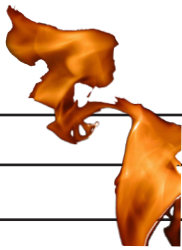

## Heating Systems

Furnaces	p. 20	Solar Thermal	p. 40
Boilers	p. 23	Passive Solar	p. 42
Stoves	p. 27	Forced Air Distribution	p. 44
Space Heaters	p. 32	Hydronic Distribution	p. 47
Electric Baseboard	p. 34	Storage Water Heaters	p. 51
Masonry Heaters	p. 36	Tankless Water Heaters	p. 53
Ground Source Heat Pumps	p. 38	Combined/Integrated Systems	p. 55

### GLOSSARY



59

### RESOURCES

Continue learning about heating systems with these helpful resources

57



## What is a heating system?



A home's heating system is responsible for meeting space heating and domestic hot water needs. Space conditioning systems are responsible for around 50% of a home's energy use, with water heating accounting for another 15-25% (U.S. Department of Energy, 2011).

---

---



The central components of the heating system are appliances that provide space heating and hot water. There are a wide variety of appliances to choose from. Alaskans use many fuels, including natural gas, fuel oil, propane, coal, wood, electricity and even the sun, to heat their homes and water. Appliances range from boilers to furnaces to stoves and beyond!

---

---

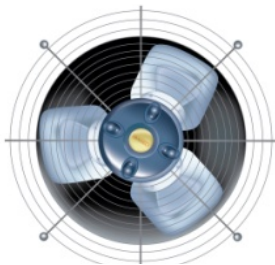

Many heating appliances provide space heating for an entire house and require a distribution system to deliver heat to every room. Distribution systems either use heated air traveling through ducts or heated water traveling through pipes to distribute heat throughout a house.

---

---

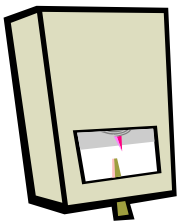

Control systems regulate when and how heating appliances and distribution systems run. Many heating appliances come with their own controls, and heating contractors can also install system controls to reduce monitoring needs and help systems save energy.

---

---

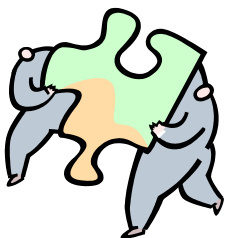

Ideally, all components work together. As the heating system is such a large energy user and is responsible for your home's comfort, a safe, efficient and cost-effective system is a necessity!



## How safe is my heating system?

Consider following these steps to help ensure that your heating system is safe. Also, ask a contractor for other safety tips.

- **Look for safety features on appliances you are considering purchasing:** Many appliances come with safety controls that prevent the device from turning on in unsafe conditions. For instance, combustion heaters often feature a high-limit switch that shuts off the heat source if the temperature in the heat exchanger is too high. This prevents the appliance from becoming too hot, which could cause the combustion chamber to crack and leak dangerous exhaust gases into a home. Ask your heating contractor to show you the safety features of the device you are considering.
- **Make sure your device is properly installed:** All heating appliances and distribution systems should be installed correctly for safe operation. On combustion appliances, it is important to ensure the chimney and air intake are properly placed. Distribution systems should also be installed properly: for example, baseboards should be located away from furniture and doors.
- **Regular maintenance:** Most heating systems need a yearly check-up from a heating professional to keep running efficiently. In addition to fine-tuning your system, your heating contractor can check that your system is operating safely. Homeowners can also perform routine maintenance such as inspecting the chimney on wood-burning appliances, emptying ash from a pellet stove, changing the air filter on a furnace, or checking that drains remain clear for a hydronic system. Check the appliance manuals for maintenance tips and ask your heating contractor what to look for!
- **Install a Carbon Monoxide (CO) detector:** CO is produced by the incomplete combustion of fuels like wood, coal, fuel oil, and natural gas. It is an odorless and colorless gas and cannot be detected by humans. In low doses, it causes headache, fatigue, and nausea. In high doses or long exposure, it can result in death! Combustion space heating appliances produce CO, which can potentially leak into a home if the appliance is installed improperly or has a cracked combustion chamber. A CO detector can prevent CO poisoning. They are available at local hardware stores for less than \$50, are battery-operated and easy to install. It is especially important to install them in bedrooms or hallways near bedrooms.

"Look for safety tips throughout this guide."



The first priority for every heating system should be that it operates safely. A heating system that backdrafts exhaust gases into a home or poses a fire hazard is a risk no matter how much heat it provides. Common safety hazards include:

- Wood stoves with improperly placed chimneys that pose a fire hazard
- Improperly installed combustion heaters such as furnaces and boilers that have the potential to backdraft poisonous exhaust gases, including carbon monoxide, into a home
- Improperly-placed or damaged electric baseboards that pose a fire hazard
- Leaks in fuel pipes that can introduce natural gas or other fuels into a home.

## How efficient is my heating system?

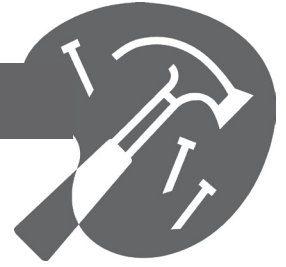

Buying a highly efficient heating appliance doesn't guarantee that your heating system will be highly efficient as well. Certainly a more efficient heating appliance means less heat will be lost up the chimney, but this won't prevent distribution system losses from air ducts or hot water pipes. If the heating appliance is installed incorrectly, it may never reach its advertised efficiency either.

When you put energy into your heating system, you have to buy the fuel (or gather firewood) and pay for the electricity to run controls or electrical heating appliances. In return, you get heat for your home. But the heat you get is what's left after heat is lost through the appliance, the distribution system, and up the chimney. In an ideal world, 100% of the heat gained from the combustion of fuel would go to space heating. That means that for every \$100 you spend on fuel, you get \$100 of heat.

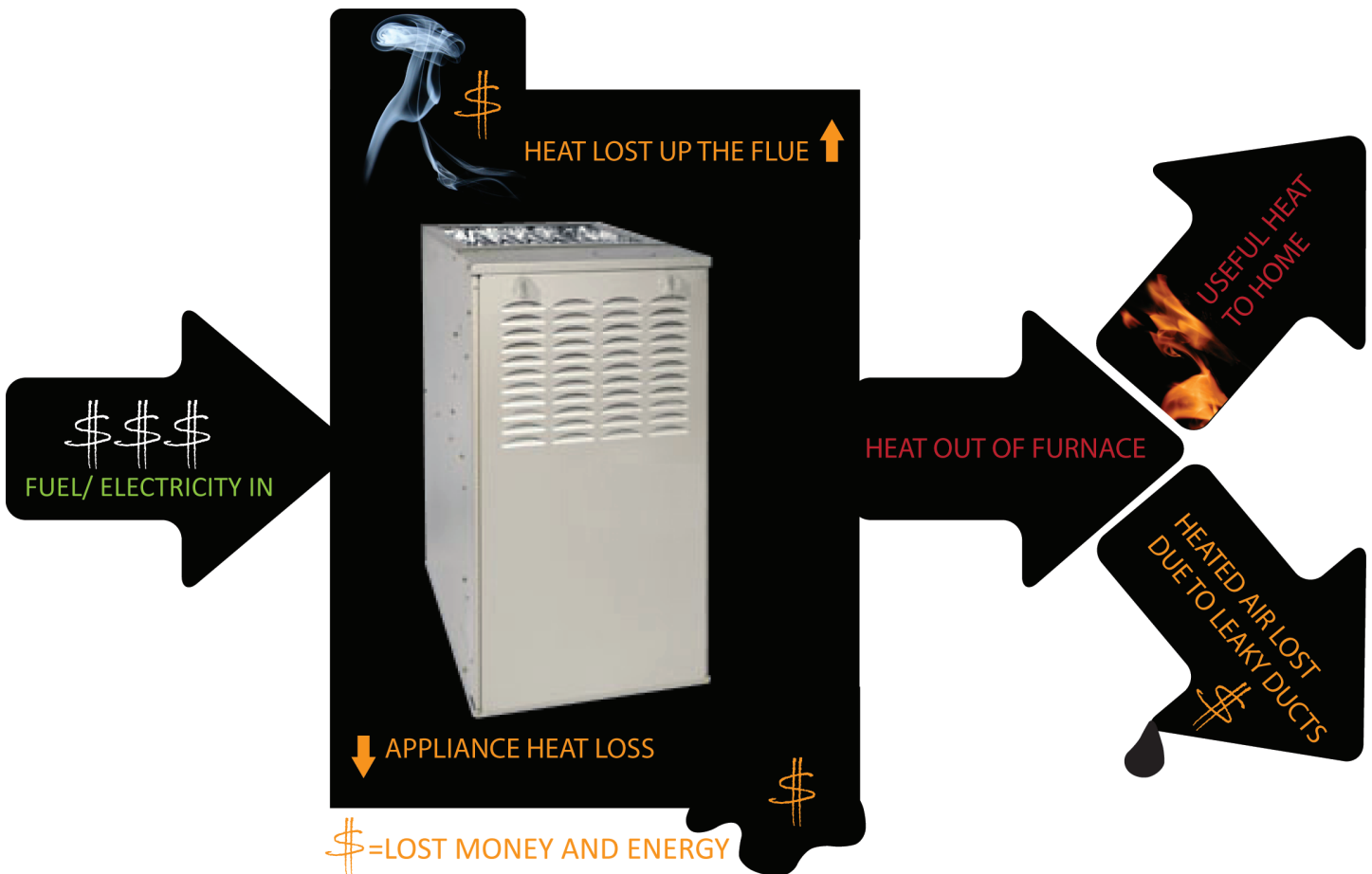
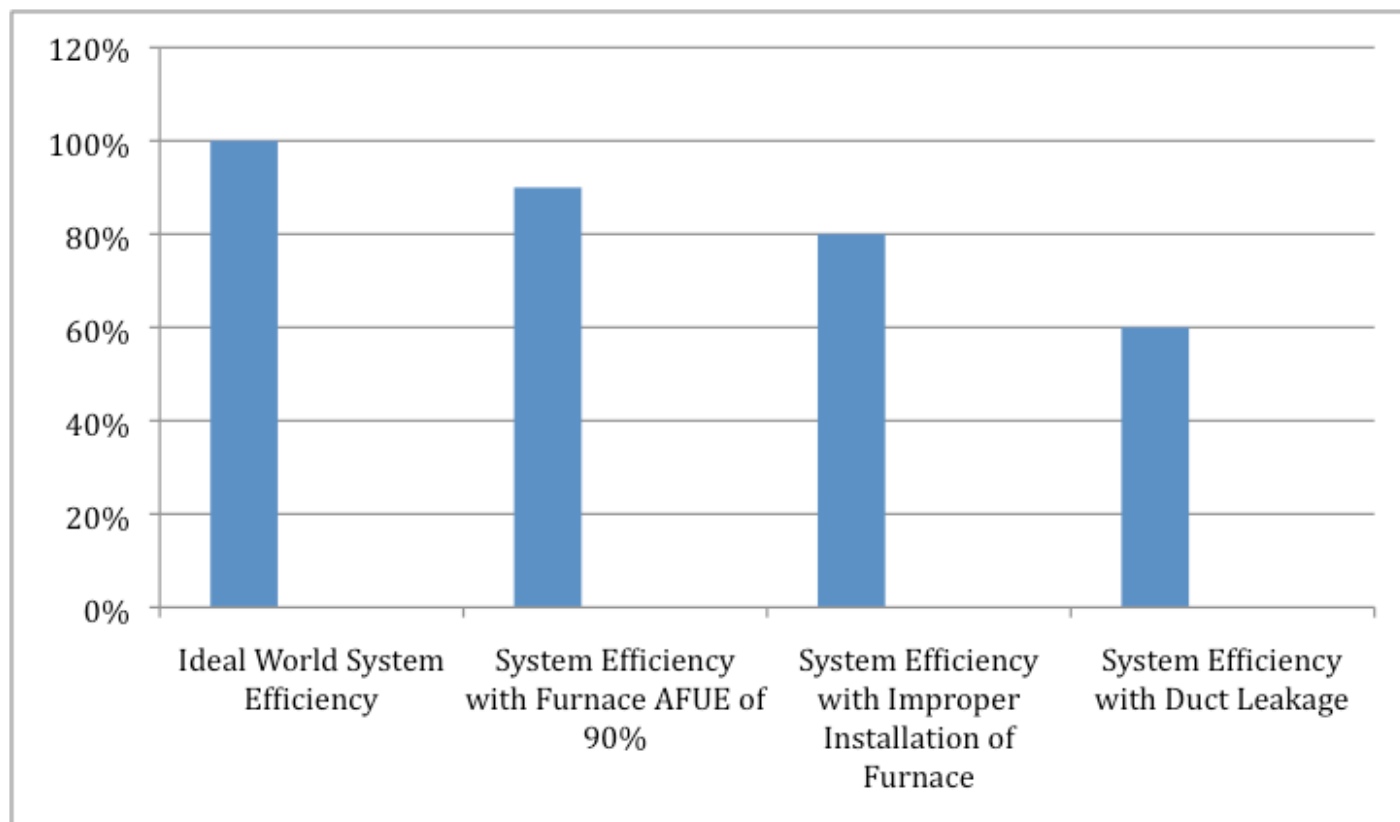

Figure based on information from the 1996 Alaska Craftsman Home Program Heating and Ventilation Manual.

## Real-World System Efficiency





The home heating system represented in the graphic above only gets \$60 of heat for every \$100 of fuel they purchase.

This homeowner purchased a very efficient furnace with an AFUE of 90%. Only 10% of heat is lost through the appliance or up the chimney. However, when the furnace was installed, it was installed improperly: it might have been the wrong size or had the controls adjusted incorrectly. This brought the system efficiency down to 80%. Finally, it has been paired with a forced air distribution system with leaky ducts. If 20% of the heated air delivered to the ducts leaks out, and isn't delivered to rooms in the home, the system efficiency will drop even further, to a final efficiency of 60%.

### So what can you do to ensure high system efficiency?

**Install a highly efficient heating appliance.** Whether you heat with a wood stove, furnace, boiler, or other appliance, buy one that is rated for high efficiency. In cold climates a more efficient heating appliance is even more important because you will use it throughout the long heating season. Of course, you need to balance efficiency with cost, but keep in mind that the most inexpensive option up-front may not be the most cost-effective in the long run.

 Look for Energy Star appliances. Energy Star is a program that labels products with higher efficiency. The same goes for wood-fired devices rated by the EPA. These devices have lower emissions, which generally means higher efficiency and less heat lost “up the chimney.”

 In colder climates, take the time to look at natural gas appliances rated by the Consortium for Energy Efficiency (CEE). The CEE has established tiers of efficiency for appliances that are used in buildings and homes. A higher tier means that an appliance is more efficient. These tiers complement the Energy Star ratings and also rank appliances that exceed Energy Star guidelines. You can find appliances ranked by the CEE on its website: [www.cee1.org](http://www.cee1.org).

### Match your appliance to a distribution system and then ensure the distribution system is efficient.

 Take care in choosing a contractor (see page 19) who will take the time to install an efficient distribution system. The contractor should test the efficiency of the system to ensure it was installed properly and follow the Energy Star Guidelines for Installation, which are based on the guidelines set by the Air Conditioning Contractors of America (ACCA). These guidelines help contractors complete a quality installation of an efficient distribution system.

 In existing systems, you can fix leaky ducts in forced air systems or insulate pipes in a hydronic system. Contractors can perform tests to check for the efficiency of your system if you do not know how efficient it is. Ask when they come for the yearly maintenance check-up.



**Get a quality installation of the heating appliance** The installation will ultimately determine if the rated efficiency of the heating appliance is realized. And, if your hot water heater is integrated with your heating appliance, then a quality installation and proper controls will ensure that the entire system operates at high efficiency.

 The heating appliance and the domestic hot water heater should be sized properly. Improperly sized systems are less efficient because they cycle on and off frequently (much like a car driving in stop-and-go traffic). Your contractor should be familiar with the Air Conditioning Contractors of America (ACCA) Manual J methods for sizing heating systems. Alternatively, they might use AKWarm software, maintained by the Alaska Housing Finance Corporation, to determine the proper size of a system.



Make sure to do any building envelope upgrades before replacing a heating system. If your home becomes more energy efficient, you will require a smaller heating appliance.



-  The air flow through a combustion appliance should be optimized. When the appliance is installed, the contractor should adjust the appliance controls to maximize the combustion efficiency of the appliance.
-  There should be adequate room around the heating equipment. This makes maintenance and repairs easier.

Systems should include zoning and a programmable thermostat (if applicable). When used properly, these control strategies can save energy.

-  Zoning divides a building or home into sections and allows a heating system to maintain different temperatures in different areas. Each zone has its own thermostat and distribution loop. Each thermostat is also connected to a central electronic device that controls heat delivery to different zones.

Guest rooms, basements and workshops are great candidates for zoning because they do not always have to be heated. Not heating them all the time saves considerable energy. Sunny rooms or rooms with wood stoves can also be zoned separately so the heat can be turned down when they warm up.

Zoning is easiest to do with a hydronic system but can also be done a forced air system. In hydronic systems, balancing valves can be used to control the flow rate and temperature drop of heated water in each zone. For forced air systems, dampers can control the supply air to different zones.



Pipes take hot water from a boiler to radiant floors in different zones of a building.

-  Programmable thermostats allow users to change the set temperature at specific times of the day or week. Instead of using a regular thermostat to keep the temperature at 68°F all the time, a family with a programmable thermostat can save energy by setting back the temperature when they are away or asleep.



Programmable thermostats can change the set temperature at different times.



Thermostats are used to communicate with heating appliances. Occupants of a home set the thermostat to a temperature that fits their comfort level. The thermostat detects when the room temperature falls below the set point and calls for the heating appliance to turn on.

To save energy, a programmable thermostat must be used properly and consistently. This involves programming several degrees of setback during the time people are asleep or at work or school. On average, turning the thermostat down by 1°F for eight hours each night will result in a 1% energy savings, although this rule-of-thumb varies according to outdoor temperatures, the type of heating appliance, and other factors (Nelson & MacArthur, 1978). A sample schedule is shown below.

To obtain the most savings, choose a temperature schedule similar to this one and program your thermostat at the beginning of winter.

Time	Event	Temperature
6:00 a.m.	30 minutes before family wakes up	70°F
9:00 a.m.	Family leaves for work and school	60°F
5:00 p.m.	30 minutes before family returns home	70°F
10:30 p.m.	Family goes to bed	65°F

### Maintain your heating system

Regular maintenance and frequent tune-ups will not only help the system run more efficiently but also:

- Increase the lifetime of your heating system
- Reduce the chance of heating system breakdown
- Reduce repair costs

Maintenance is not difficult or expensive when compared to dealing with a breakdown or replacement. There are 3 key parts to maintenance:



#### Do-It-Yourself Monitoring and Cleaning

- You can monitor your own heating system to make sure it operates properly. The manual for your heating appliance will have guidelines on what to check and how often to check it.
- Do-it-yourself maintenance tasks might include inspecting for leaks, changing filters, inspecting chimneys, and checking drains. A heating contractor can also give you tips on what to look for.



A contractor cleans and inspects a boiler



#### The Annual Tune-Up

- Most systems require a yearly tune-up. A maintenance schedule should be specified in the appliance manual, or a heating contractor can tell you how often the appliance should be tuned up by a professional. A good rule of thumb is to have the appliance inspected, cleaned, and tuned every year, just before the heating season begins.
- During a yearly tune-up, a heating professional will check the condition of the heating appliance, its flues, heat exchangers, and any electrical connections. They will lubricate moving parts, clean seals, and adjust system controls so that the appliance operates efficiently. The yearly check-up should catch problems before a malfunction occurs and help maintain equipment.
- Wood- and coal-fired devices will need a visit from a chimney sweep as well to check for rust, corrosion, and creosote buildup. They will also clean the chimney, which helps prevent chimney fires.



#### Don't Forget Your Distribution System

- Some appliances are connected to a distribution system, which delivers heat throughout the house. The distribution system also needs to be maintained and inspected. Often, a heating contractor can inspect the distribution system when he comes to check the heating appliance. When you call for an appointment, be sure to ask if a distribution system check is included.
- For forced air systems, ask if the contractor will seal ducts at connections, clean the blower, check its motor, and make sure all control components are working properly.
- For hydronic systems, the contractor should inspect the pressure-relief valve, the pressure tank, and the heat exchanger. If the system relies on steam, the safety controls should be tested and sediments removed from pipes.

## How much will my heating system cost me?



There are several items to consider when purchasing heating equipment:

- Type of fuel
- Type of heating appliance used to produce heat from your fuel source
- Type of distribution system used to deliver heat
- Efficiency of the heating appliance and distribution system

### Choosing a heating fuel

Just as you have to regularly fill your car with gasoline to keep it running, you need to supply your heating appliance with fuel. There are many different fuels out there, and their availability and cost will depend on your area. The best thing you can do is some research! Call around to distributors to find out what fuels are available in your area and how much they cost.

Type of fuel	Cost in your area	Average BTU Content (AKWarm, 1996)
Natural gas (usually sold by the therm)		100,000 (1 therm)
Firewood (usually sold by the cord)		18 million - 27 million (1 cord)
Coal (usually sold by the ton)		15.6 million (1 ton)
Electricity (usually sold by the Kilowatt-hour)		3,413 (1 kWh)
Fuel oil No. 1 (usually sold by the gallon)		132,000 (1 gallon)
Fuel oil No. 2 (usually sold by the gallon)		138,000 (1 gallon)



As you can see, the heating capability varies for different fuels. Heating capability is measured by BTUs, and 1 BTU is approximately the amount of heat given off by burning one match. To research the best bang for your buck, it is easiest to use an online calculator. Once you know the prices, you can use an online calculator to help find which fuel provides the most bang for your buck.

UAF's Cooperative Extension Wood Heating Cost Calculator:

<http://www.alaskawoodheating.com/calculator.php>

- Don't let the name of this site fool you; it isn't just for wood heating. It allows you to enter in a number of Alaska locations, home types and sizes, and fuels and their costs and calculates your estimated heating cost per year based on fuel and climate data. A more general alternative for any location: [www.buildinggreen.com/calc/fuel\\_cost.cfm](http://www.buildinggreen.com/calc/fuel_cost.cfm).

Heating Fuel Comparison Calculator: [www.eia.gov/neic/experts/heatcalc.xls](http://www.eia.gov/neic/experts/heatcalc.xls)

- This spreadsheet, from the Energy Information Administration, is a bit more comprehensive. It allows you to input both fuel prices and the efficiency of your heating device to calculate the cost of producing 1 million BTUs. Instructions are included.

## Heating appliances and distribution systems

Heating appliances and distribution systems cost money in two different ways: the capital cost you pay when you install the device and the service costs you pay afterward to maintain it. These costs will depend on your location and the installer. If you call heating contractors for estimates on different equipment install costs and service costs, you can use the following chart to help compare the cost of different systems after 5 years of maintaining them. Note that systems that require less maintenance accrue fewer costs year after year. An example is included.

	<b>Cost of heating system and installation</b>	+	<b>Cost of service (1 year)</b>	x	<b>5 years</b>	=	<b>Cost of installing and maintaining for 5 years</b>
Furnace and Forced Air Distribution	\$8000	+	\$130	x	5 years	=	\$8650
		+		x		=	
		+		x		=	
		+		x		=	
		+		x		=	
		+		x		=	
		+		x		=	

### Is buying the more energy efficient device worth it?

In general, more energy efficient devices cost more up front. However, they can pay off in the long run as higher efficiency means less heat and money are lost up the chimney.

The following table shows how much money you can save for every \$100 you spend on fuel by switching to a more efficient appliance.

Estimated Savings for every \$100 of Fuel Costs								
Current AFUE	Upgraded Appliance AFUE							
	60%	65%	70%	75%	80%	85%	90%	95%
55%	\$8.33	\$15.38	\$21.42	\$26.66	\$31.20	\$35.29	\$38.88	\$42.10
60%		\$7.69	\$14.28	\$20.00	\$25.00	\$29.41	\$33.33	\$37.80
65%			\$7.14	\$13.33	\$18.75	\$23.52	\$27.77	\$31.57
70%				\$6.66	\$12.50	\$17.64	\$22.22	\$26.32
75%					\$6.50	\$11.76	\$16.66	\$21.10
80%						\$5.88	\$11.11	\$15.80
85%							\$5.55	\$10.50
90%								\$5.30

Table based on information from U.S. Department of Energy, 2011.

You can use this table to analyze the financial benefits of buying a more efficient appliance. If you know approximately how much you spend on fuel per year, you can calculate how much you would save per year by upgrading. To do this, find the row that corresponds to the efficiency of your current appliance, then choose the dollar amount from the vertical column of the appliance you are considering purchasing. This is the amount of savings per \$100 of existing fuel bills.



Rebates may be available to homeowners for upgrades to more energy-efficient heating systems.

For the latest information on local, state, and federal incentives and policies that promote renewable energy and energy efficiency, check the Database of State Incentives for Renewables and Efficiency website: <http://www.dsireusa.org>.

For instance, upgrading from a mid-efficiency boiler with an AFUE of 80% to a more efficient boiler with an AFUE of 85% will save you \$5.88 for every \$100 of fuel that you buy. So if you previously spent around \$2000 on fuel per winter, you would save  $20 \times \$5.88 = \$117.60$  per year. Your total fuel bill would drop to \$1882.40. Is that worth the extra capital cost? Another example is upgrading a 70% efficient boiler to one with an AFUE of 90%. In this case, your heating costs would potentially drop from \$2000 down to \$1555.60, a substantial savings each year. The colder your location is and the more you spend on fuel per winter, the more you stand to save by upgrading to a more efficient appliance.



## Is my heating system the correct size for my house?

Heating appliances are sized according to the amount of heat they can produce in one hour. This heating capacity is measured in BTU/hr. A BTU, or British Thermal Unit, is a measure of heat energy. One BTU is approximately equal to the amount of heat produced by burning one match. So if you light 4 matches in one hour, you will have produced 4 BTU/hr, a very small amount of heat.

The heating capacity should match the peak hourly demand of the house. Peak hourly demand is the most heat needed by a house in one hour during a year. The peak hourly demand occurs on the coldest day of the year.

For a rough estimate, a well-insulated, two-story house in Fairbanks might require 60,000 BTU/hr on the coldest day of the year. So a heating appliance for this house should be able to produce 60,000 BTU/hr. Since the coldest day of the year in Juneau is warmer than Fairbanks' coldest day, a heating system for the same house in Juneau might only require a 40,000 BTU/hr heating appliance. The optimal size of the heating appliance will depend on both characteristics of the house (size, insulation, windows, indoor temperature, appliances) and on the climate where the house is located.

### Proper sizing

A properly sized heating system will run continuously on the coldest day of the year in order to keep the inside of the home at its set temperature. This means that the system is up and running continuously at its "steady-state efficiency," the efficiency the appliance reaches after it has warmed up. The steady-state efficiency is like the miles per gallon your car gets cruising on the highway, which is much greater than the miles per gallon your car gets in stop-and-go city traffic.

Oversized systems do not run continuously for several hours. Instead, they tend to cycle on, produce a lot of heat, and turn back off. This cycling on and off is like driving in stop-and-go traffic: It isn't efficient. Fuel is wasted while the appliance ramps up and cools down. In addition, cycling on and off causes wear and tear on the mechanical system, which means more maintenance will be needed.



A hot fire burns more efficiently.

Wood- and coal-fired devices can also be oversized. When a wood stove is too large, residents tend to burn fires at a low smolder to prevent overheating their house. This is not only less efficient than burning a hot fire, it also emits more particulates and contributes to air pollution.



Space heating and domestic hot water appliances must be sized properly. Oversized systems cost more up front and will operate inefficiently. A study conducted in 2002 concluded that, on average, forced-air heating systems in Southcentral Alaska are oversized by 121% (Kaluza, 2002). An understanding of heating system sizing can save energy and money.

Proper sizing also applies to domestic hot water systems. For instance, storage hot water systems are sized according to their First Hour Rating. The First Hour Rating is the amount of hot water in gallons the heater can supply per hour, assuming that it starts with a full tank of hot water. It is determined from the size of the water tank, the source of heat, and the size of the burner or element. It should be within a few gallons of a building's peak hourly demand. For a household with 3 occupants who routinely shower in the evening while running a dishwasher, the peak hourly demand might be around 45 gallons. This house would then need a domestic hot water heater with a First Hour Rating of 40-50 gallons.

The cost of heating appliances depends on their size. Oversized systems, in addition to being too large, cost more up front than properly sized systems. That money is better spent on an installer who will perform a proper sizing calculation.

### Is your system properly sized?

Your contractor should not use a rule-of-thumb method to size your heating system. Nor should they retrofit your house with a heating appliance the same size as the one you are replacing without first doing a sizing calculation, especially if you have upgraded the thermal envelope of your house. If they do, find another contractor. In Alaska, contractors should use one of two methods to determine the proper size of your heating system:

1. The Air Conditioning Contractors of America (ACCA) provides sizing methods in the ACCA Manual J. Contractors might use up-to-date computer programs that conform to these methods.
2. AKWarm software, maintained by the Alaska Housing Finance Corporation, will size heating systems. Energy raters and contractors in Alaska may use this software to size a heating system.

Ask your contractor which method they use, and ask to see the calculation.



You can calculate your hot water peak hourly demand at the Energy Saver's website on hot water heaters: <http://1.usa.gov/pLDv5V>.



Make sure to do any building envelope upgrades before replacing a heating system because if your home becomes more energy efficient, you will require a smaller heating system.





## Should I replace my existing heating system?

If you are considering replacing your heating system, look at the questions in this section. A “yes” to any of them may warrant a call to an energy rater or heating contractor (see below for who would be the best to call).

**Energy raters** will look at your entire house, measuring doors and windows, checking insulation levels, assessing your heating system and checking for drafts and leaks. They will input the data they collect into AKWarm, software maintained by the Alaska Housing Finance Corporation that calculates energy ratings. The rating, which will be mailed to you, describes how efficient your house currently is and suggests ways to improve the rating. These suggestions may or may not include the heating system. If you have never had your house rated and haven’t ever considered any upgrades to your house (heating system, windows, adding insulation), then calling an energy rater is a good place to start. The rating will help prioritize upgrades, show the energy benefits of each one, and may make you eligible to participate in the Alaska Home Energy Rebates Program.

**Heating contractors** will focus specifically on your heating system, estimate its current efficiency, and evaluate whether it is sized properly. In addition, they can test for the efficiency of some distribution systems. A heating contractor will have information for you on improving your current system and on purchasing new appliances. Visit the next section on How to Choose a Contractor before calling so you know what to look for.



How efficient are your windows?



For a list of certified energy raters in your area, information on AKWarm software, and information on the Home Energy Rebates Program, please visit the Alaska Housing Finance Corporation website [www.ahfc.state.ak.us](http://www.ahfc.state.ak.us).

To schedule a rating, visit [www.akrebate.com](http://www.akrebate.com).

## Have you recently upgraded the thermal envelope of your house?

The thermal envelope of your house is everything that separates the living space from the outside. It includes walls, the roof, doors and windows, and any insulation included in those items.

If you have been sealing leaks, eliminating drafts, replacing old windows with double-pane or triple-pane versions, or adding insulation, you have been making your home more energy efficient.

With thermal envelope upgrades, the home will lose less heat in the winter and therefore the heating appliance won't need to provide as much. This means your heating appliance is probably oversized. It may be time to replace it with a properly sized appliance that will operate more efficiently.

## Is your current heating appliance more than 20 years old?

Technology marches on. Appliances made today are much more efficient than older models. They are safer, use less fuel, and have more advanced controls to improve efficiency. Also, the methods to size a heating system are better and can be tailored to individual homes. A properly sized, more efficient heating appliance will save you money.

## Is your house uncomfortable?

Do you have rooms that are always too hot or too cold? This can be the result of air leaks, a lack of insulation, an improperly sized heating appliance, or not zoning your heating system. Start with a call to an energy rater to find out which improvements you can make to solve this problem. If you need to add insulation or seal leaks, do that before upgrading your heating system so that the heating system will be sized properly for your home.



To see how much money you could save each year by upgrading, see the Economics section on page 12.



## How do I choose a contractor?

When choosing a contractor to install a new heating system or retrofit, it is important to obtain multiple bids. The cheapest option may not be the one with the highest quality installation. Use this checklist to compare different contractors.

Contractor Name:

Phone Number:

	Yes	No
<b>Referrals and license</b>		
Referred by a friend, coworker, or neighbor?		
Was the contractor able to provide you with names of past customers you can call to ask about their experience?		
In Alaska, mechanical contractors must be licensed by the Division of Corporations, Business and Professional Licensing. To check if a contractor is licensed, refer to the Alaska State Website: <a href="http://www.dced.state.ak.us/occ/pcon.htm">http://www.dced.state.ak.us/occ/pcon.htm</a> Is the contractor licensed?		
All contractors should carry insurance. Ask your contractor to see a copy of his or her insurance and verify it is not expired.		
<b>Home Evaluation and Sizing</b>		
Will the contractor inspect your home and current system to evaluate your needs? This inspection should take at least an hour.		
Does the contractor use ACCA Manual J or AKWarm to size a heating system?		
If you are replacing a system, did the contractor ask to see the information from your previous system, such as maintenance records?		
For existing distribution systems, will the contractor test for leaks before AND after improvements are made? Results of both tests should be given to you.		
<b>Equipment</b>		
Will the contractor install ENERGY STAR equipment?		
Will the contractor leave you with the equipment manual, warranty information, and AHRI certificate for your purchased equipment?		
Is the contractor willing to install extra controls, such as zoning, a programmable thermostat, or time-delay relay and show you how to use them properly?		
Will the contractor show you what maintenance you can do on your own and help you set up a maintenance schedule for professional check-ups?		
Does the contractor also provide maintenance, or can they recommend a service company?		
<b>Proposal</b>		
Does the written proposal contain a timeline for installation and payment?		
Does the written proposal have itemized estimates?		
Does the contractor know about potential rebates available for buying energy efficient equipment?		

# FURNACES

## Fuel

Furnaces can use a variety of fuels. This section covers those that use natural gas or fuel oil for combustion and those that use electric heating elements. All of these furnaces require electricity, so they cannot be used during a power outage.

## Distribution System

Furnaces produce heated air, so they are paired with a forced air distribution system. Ducts are used to deliver heat to rooms throughout a home.

## How it Works

Furnaces are the most commonly used residential heating system in the United States (Energy Star, 2009). Furnaces heat air that is distributed throughout a building by ducts. In natural gas or oil furnaces, the fuel is mixed with air and then burned in a combustion chamber. Air is pushed through a heat exchanger by a fan, and then pushed into the distribution ductwork. Meanwhile, combustion gases must be vented out of the building through a flue. Electric furnaces do not have a combustion chamber. Instead they have heating elements that convert electricity into heat. Air is pushed through the heating elements by a blower, and then the heated air goes to the distribution system.

**Furnace vocabulary** These vocabulary terms are used to describe types of combustion furnaces that use natural gas or fuel oil. You might encounter them when shopping for a furnace.

*Natural draft furnaces* rely on the buoyancy of hot combustion exhaust. The exhaust is hot, so it rises out of the flue. As the hot exhaust gases exit upwards, the draft causes fresh air to passively enter the combustion chamber through a vent. Because natural draft furnaces consume a large amount of air in this process, they are less efficient than mechanical draft furnaces. If the air pressure inside the house is lower than the air pressure outside, then a natural draft furnace can backdraft, and poisonous gases such as carbon monoxide can enter the home.



Natural gas is a colorless gas found in the upper parts of oil and gas wells. Raw natural gas is a mixture of methane, propane, butane, and other gases. Refinement removes some of these gases and adds an odor that allows people to smell a gas leak. The exact make-up of the natural gas for a given location depends on the gas source and the refinery that processed it.

In cities, natural gas is distributed to homes by a central piped system. This system exists in Anchorage and in parts of Fairbanks and Barrow. If you receive natural gas from a piped system, you will typically be billed monthly for the gas that you use (similar to how an electric company bills you). Households without access to a piped distribution system can still use natural gas, such as propane, for heating. Propane can be bought in refillable pressurized containers or can be delivered to your home from a distributor in some areas.



Furnaces produce heated air.

*Mechanical draft furnaces* use a fan to draw in combustion air. The fan also creates turbulence in the combustion chamber, allowing for a more complete burn. These are usually more efficient than natural draft furnaces.

*Sealed combustion furnaces* use a duct to bring in outside air directly to the combustion unit and a flue to exhaust gas outside. The combustion chamber (where burning occurs) is sealed off from the inside of the home. These furnaces are very safe, because poisonous exhaust gases, such as carbon monoxide (CO), cannot enter a home.

*Condensing furnaces* are more efficient than standard combustion furnaces. A condensing furnace is able to reclaim some heat from the exhaust gas by cooling it to a point where the water vapor from combustion condenses out. Condensation releases latent heat from the gas, and this heat is captured by a second heat exchanger. The condensate water is acidic (it has the same acidity as some vinegars), so materials like stainless steel or PVC pipe are used for the heat exchanger and pipes because they will not corrode. Condensing furnaces have a drain that allows the water to enter the wastewater plumbing system. In older homes with pipes that could corrode, a neutralizing filter can be added to the drain line. They also have a fan to blow the cooler exhaust gas, which is not buoyant enough to exit the flue on its own, outside the building.

*Non-condensing furnaces* are less efficient because they have to operate at higher temperatures to prevent condensation. However, they do not require a drain and can be made of materials such as iron, steel, or copper that would eventually corrode in a condensing furnace.

## Maintenance

Furnaces should be checked yearly by a heating professional, preferably right before the heating season. The heating professional will check the condition of the furnace and its vents, heat exchanger, and flue. He will check and adjust controls for pressure and air intake and can perform tests to measure efficiency to make sure the furnace is working properly. For electric furnaces, a contractor will inspect system controls and the electric connections to make sure they are working properly. You also can and should inspect your furnace and change the air filters. To do this, first look in the manual for the appliance. It will give you guidelines on how often and what to check (for instance, for most furnaces you need to change the air filter every few months). You can also ask a heating contractor for tips on what to look for.

## Efficiency Range

When you buy a combustion furnace, you will see a combustion efficiency, a steady-state efficiency, and an Annual Fuel Utilization Efficiency (AFUE) listed. Electric furnaces will only have an AFUE listed, as they do not use combustion for heating. The AFUE is a seasonal efficiency and is the best representation of the efficiency the furnace will have in your house. It is given as a percentage. A furnace with a higher AFUE will be more efficient and save you money. For instance, if your furnace has an AFUE of 70%, then for every \$100 you spend on fuel, 70 dollars will be heat delivered to the heat distribution system, and 30 dollars will be lost up the chimney.



Improperly installed or broken combustion furnaces may backdraft combustion gases into a home. These include carbon monoxide (CO), an odorless gas that is deadly for humans to breathe. All homes with combustion furnaces (including those with sealed combustion chambers) should have a carbon monoxide detector. In fact, Alaska Statute 18.70.095 states that qualifying dwelling units [which include those heated by combustion appliances] must have a carbon monoxide alarm. Carbon monoxide alarms are available in hardware and department stores for less than \$50 and can save your life.



If you don't want to buy a new natural gas or fuel oil furnace or boiler, ask your heating contractor about retrofitting your current one to be more efficient:

- Installing a vent damper will prevent heat from being lost up the chimney when the gas- or oil-fired boiler or furnace is not on. The vent damper seals off the flue for exhaust gases. It must be installed with controls so that the vent damper opens when the device fires.
- If your furnace or boiler is oversized and you don't want to replace the entire device, you can reduce its capacity by having a professional de-rate or replace the burner. The burner is the part of the furnace or boiler that mixes the natural gas or fuel oil with air and ignites it. De-rating the burner will make an oversized device run more efficiently by reducing the amount of fuel that is available to burn. This makes the appliance less powerful, effectively reducing its capacity.
- If you are looking to replace the burner anyway, consider replacing it with a flame-retention burner. These burners cost more up front, but they use a high-speed motor to produce high air pressure that mixes fuel and air. The motor also produces a swirling motion that causes the flame to be more compact and stable. This results in cleaner and more complete combustion, which means a more efficient device.

Low efficiency combustion furnaces have an AFUE of 60-70%. These are typically older models and have natural draft. Low-efficiency natural gas systems have a continuous pilot light. Now, The Department of Energy mandates that all furnaces currently on the market have a minimum AFUE of 78%.

Energy Star-rated combustion furnaces have an AFUE of more than 85% (fuel oil) or 90% (natural gas). However, other high efficiency systems have an AFUE of up to 97%. They feature sealed combustion chambers and are condensing models. Electric furnaces have AFUEs of 95-100%, with the lower efficiencies corresponding to furnaces that are located outside, and lose heat to the outside air.

### Difficulty of retrofit or upgrade

Furnaces can be easily upgraded. Installing a furnace into an existing house that previously had a different heating appliance may be more difficult depending on the distribution system. Furnaces produce heated air, so they require a forced air or duct distribution system. If a home does not currently have a duct distribution system, another heating appliance might be a better choice because installing ducts requires construction work.

Advantages	Disadvantages
<ul style="list-style-type: none"> <li>• Furnaces are very common appliances, so there are a wide range of products to choose from. In addition, there are many service and installation professionals in most areas.</li> <li>• Furnaces use a forced air distribution system, which can also be used for cooling and humidification.</li> </ul>	<ul style="list-style-type: none"> <li>• The price of space heating is tied to the price of oil or natural gas, which can be volatile. The price may rise with inflation and changes in the world market.</li> <li>• Furnaces use a forced air distribution system, which is typically less efficient than a hydronic distribution system. The fans used in forced air systems typically require more electricity than pumps for a hydronic system.</li> <li>• Furnaces require electricity to run, so cannot be used in a power outage.</li> <li>• The high cost of electricity in most places in Alaska means that heating with an electric furnace will be expensive.</li> </ul>

# BOILERS

## Fuel

Boilers may use a variety of fuels. This section covers those that use natural gas or fuel oil for combustion and those that use electric heating elements. All three types of boilers require electricity, so they cannot be used during a power outage.

## Distribution System

Boilers produce heated water or steam. If the boiler produces hot water, it uses a hydronic distribution system. Such a system uses pipes to deliver the hot water to baseboards, radiators, or a radiant floor. Steam boilers are less common. They must operate at a higher temperature and are less efficient than hot water boilers. If the boiler produces steam, it is distributed through pipes and radiators throughout the home.

Hybrid distribution systems that produce both heated water and heated air are also possible. For example, a radiant hydronic system can be used throughout a home, and then a fan blows air through coils of heated water for distribution in a garage or workshop.



Fuel oil No. 1 can be stored in above-ground tanks.

## How it Works

Boilers, along with furnaces, are one of the most common heating systems in Alaska. Boilers heat water to provide either hot water or steam, which is then delivered to a hydronic distribution system to provide space heating.



Boilers can provide both domestic hot water and space heating.



Fuel oil comes from crude oil, which is removed from the ground and offshore in 100 countries worldwide. In the United States, crude oil is produced in 31 states. In 2010, Alaska was the second-largest oil producing state, providing 11% of the U.S. domestic oil production (U.S. Energy Information Administration, 2011). After crude oil is removed from the ground, it is sent to a refinery and separated into useable petroleum products, one of which is heating oil.

Fuel oil that is used for heating is further classified into grades. Grades 1 and 2 are distillates (lighter oils). Grade 1 heating oil (also known as kerosene or fuel oil No. 1) is often used in buildings with an above-ground storage tank (usually for direct-vented space heaters). Grade 2 heating oil (also called fuel oil No. 2) is heavier and more commonly used than Grade 1 for residential or commercial heating. It is typically stored in a tank below ground as it will gel at temperatures of around -15°F. It is advantageous because it contains a higher BTU/gallon than Grade 1 and typically costs less per gallon.

In an oil-fired or natural gas system, a pump pressurizes the fuel, which is then ignited in the combustion chamber. The burning fuel passes its heat to the water in a heat exchanger. Meanwhile, combustion gases must be vented out of the building through a flue. Electric boilers do not have a combustion chamber. Instead they have heating elements that convert electricity into heat. The heating elements heat water that then goes to the distribution system.

**Boiler Vocabulary** These vocabulary terms are used to describe types of combustion boilers that use natural gas or fuel oil. You might encounter them when shopping for a boiler.

*Natural draft boilers* rely on the buoyancy of hot combustion exhaust. The exhaust is hot, so it rises out of the flue. As the hot exhaust gases exit upwards, the draft causes fresh air to enter the combustion chamber. Because natural draft boilers consume a large amount of air in this process, they are less efficient than mechanical draft boilers. If the air pressure inside the house is less than the air pressure outside, a natural draft boiler can backdraft and poisonous gases such as carbon monoxide can enter the home.

*Mechanical draft boilers* use a fan to draw in combustion air. The fan also creates turbulence in the combustion chamber, allowing for a more complete burn. These are usually more efficient than natural draft boilers.



If you don't want to buy a new natural gas or fuel oil furnace or boiler, ask your heating contractor about retrofitting it to be more efficient. Check out the tips on page 22 and consider installing a modulating aquastat: Aquastats regulate boiler temperatures to keep them within a prescribed range. A modulating aquastat (also called an outdoor reset) can set the temperature of the hot water a boiler produces based on the outdoor temperature so it's only as hot as needed. This is a relatively inexpensive way to save energy during the shoulder seasons.



Some boilers (and furnaces) use firewood as a fuel. In these appliances, firewood is loaded into a firebox and lit. The heat from the fire goes to a distribution system so it can be delivered throughout a home. Some people prefer wood-fired boilers and furnaces, which can be used in combination with a natural-gas, fuel oil or electric furnace or boiler, because firewood is a renewable resource that can be gathered by the homeowner.

Also, these appliances can be located outside where they can heat 2 buildings (for instance, a home and a workshop). In addition, many wood-fired boilers and furnaces do not require electricity to run. If you are thinking of purchasing a wood-fired boiler, look for one that qualifies for the EPA's Phase 2 White Hang Tag program. Qualifying boilers, which have a white hang tag, are approximately 90% cleaner than other models. See [www.epa.gov/burnwise](http://www.epa.gov/burnwise) for more information.



A boiler produces heated water or steam.



*Sealed combustion boilers* use a duct to bring in outside air directly to the combustion unit and a flue to vent the exhaust outside. The combustion chamber (where burning occurs) is sealed off from the inside of the home. These boilers are very safe, because poisonous exhaust gases such as carbon monoxide (CO) cannot enter a home.

*Condensing boilers* are more efficient than standard combustion boilers. A condensing boiler is able to reclaim some of the heat in the exhaust gas by cooling it to a point where water vapor from combustion condenses out. The condensation releases the latent heat from the gas, and this heat is captured by a second heat exchanger. The condensate water is acidic (it has the same acidity as some vinegars), so materials like stainless steel or PVC pipe are used for the heat exchanger and pipes. Condensing boilers must have a drain that allows the water to enter the wastewater plumbing system. In older homes with pipes that could corrode, a neutralizing filter can be added to the drain line. They also have a fan to blow the cooler exhaust gas, which is not buoyant enough to exit the flue on its own, outside the building.

*Non-condensing boilers* are less efficient because they have to operate at higher temperatures to prevent condensation. However, they do not require a drain and can be made of materials such as iron, steel or copper that would eventually corrode in a condensing boiler.

## Maintenance

Boilers should be checked yearly by a heating professional, preferably right before the heating system. The heating professional will check the condition of the boiler and its vents, heat exchanger, and flue. He will also check and adjust pressure and air intake and measure the boiler's efficiency to ensure it is working properly. For electric boilers, a contractor will inspect system controls and the electric connections to make sure they are working properly.

You should also inspect your boiler. The manual will give you guidelines on how often and what to check. You can also ask a heating contractor for tips on what to look for.



A modulating aquastat will change the output temperature of a boiler based on the outdoor temperature.



Improperly installed or broken combustion boilers may backdraft combustion gases into a home. These include carbon monoxide (CO), an odorless gas that is deadly for humans to breathe. All homes with combustion boilers (including those with sealed combustion chambers) should have a carbon monoxide detector. In fact, Alaska Statute 18.70.095 states that qualifying dwelling units [which include those heated by combustion appliances] must have a carbon monoxide alarm. Carbon monoxide alarms are available in hardware and department stores for less than \$50 and can save your life.

### Efficiency Range

When you purchase a boiler, you will see a combustion efficiency, a steady state efficiency, and an Annual Fuel Utilization Efficiency (AFUE) listed. Electric boilers will only have an AFUE listed, as they do not use combustion for heating. The AFUE is a seasonal efficiency and is the best representation of your boiler’s efficiency. It is given as a percentage. A boiler with a higher AFUE will be more efficient and save you money. For instance, if your boiler has an AFUE of 70%, then for every \$100 you spend on fuel, 70 dollars will be heat delivered to the heat distribution system, and 30 dollars will be lost up the chimney.

Low efficiency systems have AFUE of 60-70%. Typically these have natural draft; natural gas boilers have a continuous pilot light. The Department of Energy now mandates that all boilers currently on the market have a minimum AFUE of 80%.

Energy Star rated boilers have an AFUE of 85% or greater, and other high efficiency systems can have an AFUE of up to 97%. They feature sealed combustion chambers and are condensing systems. Electric boilers have an AFUE of 95-100%, with the lower efficiencies corresponding to boilers that are located outside, and lose heat to the outside air.

### Difficulty of retrofit or upgrade

Boilers can easily be upgraded. Installing a boiler into an existing house that previously had a different heating appliance

may be more difficult depending on the distribution system. Boilers produce steam or heated water, so they typically need a hydronic distribution system. If a home does not currently have a hydronic distribution system, another heating appliance might be a better choice because installing hydronic systems requires construction work.

Advantages	Disadvantages
<ul style="list-style-type: none"> <li>• Hot water boilers can be paired with a hydronic distribution system. Hydronic systems are more efficient than air distribution systems.</li> <li>• Boilers allow for greater flexibility in distribution options because they can produce heated air by passing the heated water through a heat exchanger.</li> <li>• Boilers are very common appliances, so there are a wide range of products to choose from, and service and installation professionals are easy to find in most areas.</li> <li>• Boilers can also provide domestic hot water.</li> </ul>	<ul style="list-style-type: none"> <li>• The price of space heating is tied to the price of oil or natural gas, which can be volatile. The price may rise with inflation and changes in the world market.</li> <li>• Boilers run on electricity, so cannot be used in a power outage.</li> <li>• The high cost of electricity in most places in Alaska means that heating with an electric boiler will be expensive.</li> </ul>

## STOVES

### Fuel

Stoves can use firewood, pellets, or coal as fuel.

Wood stoves may use any type of firewood as fuel. However, using properly dried wood is advantageous because less heat is lost to boiling water stored in the wood. Burning trash and other non-wood substances in a stove is not recommended. Garbage contains a wide variety of materials, including plastics and papers containing dye and ink. The smoke from these materials contains toxic chemicals that will damage your stove.

Wood can be considered a renewable resource, because trees can be planted to provide more firewood in the future. It is also carbon dioxide (CO<sub>2</sub>) neutral because the CO<sub>2</sub> released from wood burning is about the same as the CO<sub>2</sub> that would be produced if the wood decomposed.

Wood is often sold by the cord. Many wood burners chop, split, and dry some or all of their own firewood. Hence the saying that wood has the advantage of heating twice: once when you do the hard work to gather and store it, and once when you burn it.

Pellets stoves burn pellets, which are manufactured from compacted sawdust, wood chips, agricultural crop waste, waste paper, and other materials. They can also be made with biomass fuels including nutshells, corn kernels, sunflowers, and soybeans. Pellets are about 1-inch long and look like rabbit feed. The pressure and heat created during production binds the pellets together without the need for glue.



A stove can provide heat for a room or small cabin.



An auger is used to feed pellets into a pellet stove.

Pellets are usually sold in 40-pound bags and are often available at local hardware stores. They can also be obtained directly from manufacturers. Currently, there is only one pellet manufacturer in Alaska who sells pellets directly (by the bag and the ton) and through retailers in Fairbanks. Pellets made outside of the state are also available in Alaska.



Alaska who sells pellets directly

A quality installation with proper chimney support, placement, and height will ensure a strong draft and safe appliance.

Coal stoves burn coal, a combustible sedimentary rock. It is the most abundant fossil fuel produced in the United States (U.S. Energy Information Administration, 2011) and is mined in 26 states, including Alaska. Coal is primarily used for electricity production and by industry but can be used for space heating and cooking. There are four different types of coal, each with different carbon contents. While any type of coal can be used for space heating, anthracite and bituminous coal have higher BTU contents, and therefore produce more heat when burned.



Bituminous coal is one of the four types of coal.

### Distribution System

Stoves do not have a separate distribution system. The fire inside the combustion chamber causes the stove to warm up and radiate heat throughout a room.

### How it Works

Stoves are designed to heat a space directly. A stove consists of a combustion chamber, ash tray, and a flue to vent exhaust gases. They are installed with a floor pad to protect flooring from embers or ashes.

Some stoves rely on natural draft to supply combustion air and draw air from the room up through grates at the bottom of the stove. To distribute heat to the room, they rely mostly on radiation. The fire in the firebox warms the entire stove, which then radiates heat to the room. Larger stoves can be used to heat an entire house, but will work most effectively in houses with an open floor design so that the heat can spread easily. Wood and coal stoves are very similar, but each has a slightly different design to improve efficiency. Coal and wood should not be burned in the same stove, unless the stove has been designed for both fuels. When you choose a stove, be sure to ask if it is designed for coal or wood.



Coal stoves have a similar design to wood stoves.

Pellet stoves work similarly to wood and coal stoves in that they have a combustion chamber, ash tray, and flue for exhaust gases. However, pellet stoves require electricity to move pellets from a hopper to the combustion chamber, using a screw auger. The hopper is usually large enough to hold enough pellets to last for more than a day. Pellet stoves can be direct-vented from a wall, meaning that no chimney is required.

Pellet stoves have three motorized systems:

- The screw auger feeds pellets to the fire at a controlled rate,
- An exhaust fan vents exhaust gases and draws in combustion air,
- A circulating fan forces air through the heat exchanger and into the room.

All stoves should be designed so they can be completely closed when not in use. This prevents heated air in the home from escaping up the chimney.



**Wood stove design terms** There are two main types of wood stoves that you might encounter when looking for a wood stove.

*Catalytic* stoves route exhaust gas through a coated ceramic honeycomb device. The honeycomb device acts as a catalyst and causes the smoke gases and particles to ignite and burn. This allows the stove to burn cleanly and to extract more heat from the exhaust. They are a good match for people who are looking to have long, low temperature burns from their stove.

Catalytic stoves have a bypass damper to the flue. When the stove is lit, the damper is opened so that gases can bypass the honeycomb (which restricts gas flow). After the fire is burning strongly, the damper can be closed so that gases will again pass through the honeycomb. The honeycomb device does need to be replaced every few years. The life of the honeycomb will be longer if the stove is cleaned often, if it is properly used, and if only firewood is burned.

*Non-catalytic* stoves do not use a catalyst. Instead they have other characteristics that create a good environment in the firebox for complete combustion:

1. The firebox is insulated so that less heat from the fire leaks away.
2. They have a large baffle that causes the hot gas from the fire to take a longer path out the flue.
3. They introduce pre-heated combustion air into the firebox.

Smoke from fires in stoves contains microscopic particulates that can cause a number of health problems like runny noses, burning eyes, and bronchitis, so it's important to limit your exposure to smoke. Particulates pose additional danger to children and people with lung disease, such as asthma. EPA-qualified stoves are cleaner burning and release fewer particulates into the air around your house.

You are responsible for lighting and maintaining the fire and cleaning the firebox in a coal stove. There is a chance of being burned and it is important to follow proper procedures for the appliance in lighting fires, maintaining fires, and cleaning.



Some wood, coal, and pellet-fired boilers are designed to heat an entire house. See the section on boilers (page 23) for more information.

Non-catalytic stoves make up the majority of stoves on the market. The baffles have to be replaced every few years, depending on how often the stove is used and whether non-wood fuels such as trash are burned (trash should never be burned in a wood stove). Non-catalytic stoves are typically chosen by people who are using their stove as their primary heat source.

## Maintenance

Solid fuel-burning appliances require frequent maintenance. The ashtray should be cleaned out with each use and the stove should be inspected regularly.

A yearly check by a maintenance professional and a chimney sweep is also required. A build-up of creosote (a tar-like substance that is produced when the fuel does not burn completely) in a chimney can cause chimney fires. In addition, rust or corrosion can cause a chimney to break. These problems should be caught early, so the chimney can be replaced before it malfunctions. Maintenance professionals can also check other parts of the stove, such as doors, gaskets and seals to make sure they are in good condition. For pellet stoves, the maintenance professional will also check electrical connections.

## Efficiency Range

Unfortunately, there is no standardized efficiency for wood and coal stoves such as AFUE for furnaces and boilers. Wood and coal stoves can be anywhere from 40-75% efficient at transferring heat from the fuel to the room, instead of up the chimney. However, be aware that reported efficiencies may vary depending on the method used to measure them. In general, more efficient stoves have a design that facilitates a hotter, cleaner, and more complete burn. Also, look for models certified by the United States Environmental Protection Agency (EPA), which are approximately one-third more efficient and produce 90% less smoke than conventional stoves.



The chimney in a wood- or coal-fired device leaks warm air out of a room when the appliance is not in use. If you have a wood- or coal-fired heating stove that is not used very often, you can buy an inflatable stopper or flue damper that will close the flue when the stove is not in use. These devices, available at hardware stores, temporarily seal the chimney so heat doesn't leak out. Just be sure to remove it to open the flue before lighting a fire!

Pellet stove efficiency ratings are published by pellet stove manufacturers. The efficiency ratings are a combination of electrical efficiency, combustion efficiency (a measure of the heat produced from burning fuel), and heat transfer efficiency. Efficiencies can range from 80% to more than 90%. More efficient stoves will lose less heat up the chimney and deliver more heat into the home.



Bags of pellets ready for distribution.  
Photo courtesy of Pellet Fuels Institute.

## Difficulty of retrofit or upgrade

A stove can easily be upgraded to a newer or more efficient model. They may also be installed into an existing home, but it is important to properly place the device so that the flue has a straight path outdoors.



The Environmental Protection Agency's (EPA) BurnWise program maintains a website <http://www.epa.gov/burnwise> that contains consumer information on choosing the right wood or pellet appliance, best burning practices, and maintenance. It also contains a list of wood- and pellet-burning appliances that have been certified by the EPA to meet emission and particulate standards.

Also, the Canada Mortgage and Housing Corporation (CMHC) publishes a Guide to Residential Wood Heating that covers types of wood heaters, installation procedures, maintenance requirements, and tips on burning wood efficiently. This comprehensive resource is available on CMHC's website: [www.cmhc-schl.gc.ca/en](http://www.cmhc-schl.gc.ca/en).

The Pellet Fuels Institute [www.pelletheat.org](http://www.pelletheat.org) lists current pellet standards and has information about pellet stoves. There is a cost comparison application on the website that can help you compare the cost of pellets in your area to the other available heating fuels.

Advantages	Disadvantages
<ul style="list-style-type: none"> <li>• Wood and pellets are considered renewable resources.</li> <li>• Gathering wood and cutting firewood is an enjoyable form of physical fitness for some.</li> <li>• Wood and coal stoves can still be used during an electrical power failure.</li> <li>• A fire in a stove has aesthetic appeal.</li> <li>• Stoves are common in many Alaskan locations, so there is a variety of models to choose from and an availability of maintenance professionals.</li> <li>• Many pellet stoves have controls that allow for unattended, controlled heating for up to 24 hours.</li> </ul>	<ul style="list-style-type: none"> <li>• Stoves, especially older models, produce air pollution in the form of combustion gases. This problem is worsened when wood is not burned properly.</li> <li>• Stoves require constant maintenance in tending to the fire, emptying the ashtray, and cleaning the chimney.</li> <li>• The safety of stoves is dependent on proper use and maintenance.</li> </ul>

## SPACE HEATERS

### Fuel

Propane or natural gas is typically required for gas-fired heaters. Oil-fired, direct-vent heaters use Grade 1 fuel oil (kerosene). Electric space heaters are also available.

### Distribution System

Space heaters produce heated air, which is distributed throughout a room by convection. Their heat output is small compared to a furnace or boiler. Some electric space heaters provide heat through radiation. They can provide heat for a room or cabin and do not have a separate heat distribution system.

### How it Works

Combustion gas or oil-fired space heaters can be wall-mounted or free-standing. They have a combustion chamber where fuel is mixed with air and burned. The heated air is distributed to the room with a fan, where it spreads by convection.

Models with sealed combustion air systems have pipes installed through a wall to supply combustion air and exhaust combustion products. A sealed combustion design means that there will be no backdraft, which can cause poisonous exhaust gases to enter the home. Space heaters without exhaust vents should NOT be used because they are dangerous (and are illegal in Alaska). Other models have natural draft systems, which are safe when installed correctly. Sealed combustion cabinet-type space heaters are widely used in Alaska. Recent models come with programmable thermostats, multiple heat exchangers to capture combustion heat, and fans. They generally consume little electricity.

Electric space heaters convert electric current from the wall socket directly to heat in the same way a toaster or iron works. This heat then spreads throughout a room by radiation and convection.

### Maintenance

Combustion space heaters should be checked every other year by a heating professional, preferably right before the heating season. The service usually includes an appliance cleaning and check of all components. You can also check and maintain your combustion space heater. First consult the manual for tips on what to check. For instance, some models have filters that may need to be cleaned every month.

Electric space heaters require little maintenance except to keep them clean and away from furniture. However, check the manual for your appliance for other maintenance and safety tips.

### Efficiency Range

There is a wide range of combustion space heater models, and they can have an Annual Fuel Utilization Efficiency (AFUE) of 70% to 90%. Models with higher AFUEs are more efficient in converting fuel into heat for your home. A high AFUE means that less heat (and money) is lost up the chimney.



Oil-fired cabinet heaters are popular in Alaska.





Combustion space heaters that do not have exhaust vents to the outside are very dangerous because they release poisonous exhaust gases into a room. They should not be used. Those with sealed combustion systems are much safer. Homes with space heaters should install a carbon monoxide detector, available in hardware and department stores for less than \$50.

Look for space heaters that carry an Underwriter's Laboratories (UL) label, which means they have been tested for safety.



Electric space heaters are a good point source of heat. They allow the temperature of a small area to be raised without having to raise the thermostat set point for an entire home.

### Difficulty of retrofit or upgrade

Space heaters can easily be upgraded or retrofitted into a home. In retrofitting, combustion space heaters should be placed on an outside wall to give the vents access to outside air. Often, combustion space heaters can be used to heat an addition to a home or a garage.

Electric space heaters can simply be plugged into a wall. They can be moved room to room to provide extra heat where needed.

Advantages	Disadvantages
<ul style="list-style-type: none"> <li>• Space heaters can be used in larger buildings in the shoulder season when little heat is required or to augment a central heating system on cold days.</li> <li>• Space heaters can be used to heat a building addition or remodeled space.</li> <li>• Combustion space heaters are very common in Alaska and there are several models to choose from. Also, there are many service and installation professionals in the state.</li> <li>• Electric space heaters are inexpensive to purchase, portable and have no installation costs.</li> </ul>	<ul style="list-style-type: none"> <li>• The price of fuel oil and natural gas can be volatile as it may rise with inflation and changes in the world market.</li> <li>• Unvented combustion space heaters emit pollutants, including carbon monoxide, into buildings that cause health hazards or death. They should not be used.</li> <li>• Most space heaters run on electricity and cannot be used in a power outage.</li> <li>• Electric space heaters can be very expensive to operate in areas with a high cost of electricity.</li> </ul>

## ELECTRIC BASEBOARD

### Fuel

Electric baseboard heaters use electricity to provide heat.

### Distribution System

Electric baseboard heaters are located in the rooms that they heat. They produce heated air, which spreads through a room by convection.

### How it Works

Electric baseboards convert electricity directly from the wall socket to heat, using the same method as a toaster or iron does to provide heat.

Heated air is distributed from the baseboard by convection, so no fans are needed. Cold air enters the baseboard from the bottom of the room and is heated by the electric element before rising out of the baseboard. The rising warm air sends cold air to the floor of the room. Baseboards can be used as a primary heating system or to supplement heat in rooms where the central heating system is not adequate.

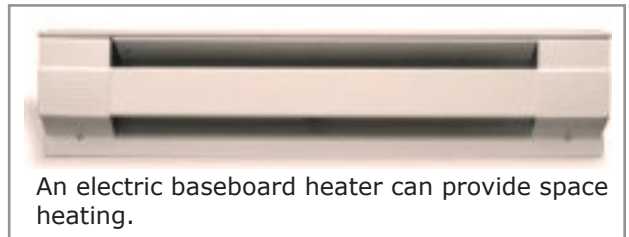

An electric baseboard heater can provide space heating.

### Maintenance

Electric baseboards should be kept clean. Look in the manual

for instructions on how and when to dust and vacuum around the electric baseboards.

### Efficiency Range

The efficiency of baseboards is 100% because all of the “fuel,” or electricity, is converted into heat. In addition, there are no distribution losses because electricity is converted into heat at the baseboard. However, baseboards should be placed properly (not blocked by furniture) and kept clean to reach their full efficiency. Damaged baseboards can also have lower efficiency.



Electric baseboards are very safe if installed and used correctly. They do not depend on combustion so there are no combustion products.

However, it is important to place the baseboard units correctly. They should be out of the way of furniture and doors that may bump them. Improperly placed electric baseboards can start house fires!

Remember that electricity is a secondary source of energy and that the price and ultimate efficiency of heating with electricity depends on the fuel used at the power plant. This is an especially important consideration for Alaska villages with diesel generators. In this case, the price of heating with an electric appliance will still be heavily dependent on the price of diesel used to create the electricity. On the other hand, electricity that comes from a renewable resource such as hydropower is more likely to have more stable (and lower) prices. If you plan to heat using an electric appliance be sure to compare the price of electricity with other fuels in your area as electricity is commonly more expensive.



Electricity is a secondary energy source, since it is created from other energy sources. Those sources may be renewable (such as wind) or non-renewable (such as coal or natural gas). Electricity in the Lower 48 is generally created at electrical plants and distributed by power lines to buildings and homes, which have meters to track how many kilowatt-hours they use. Electric companies bill customers monthly for the power they consume.

Electricity in most of Alaska is distributed differently than in the contiguous United States, because most of the state is not connected to a grid infrastructure. While there is one interconnected grid that services the railbelt (Fairbanks to the communities south of Anchorage), rural communities rely mostly on diesel electric generators.

The electricity on the railbelt grid in Alaska is primarily fueled by natural gas (around 60% of the total) with other sources including hydroelectric power (around 20%), petroleum (less than 10%) and coal (less than 10%). Other renewable energy sources used for electricity in Alaska include a geothermal plant and small wind farms (U.S. Energy Information Administration, 2011).

### Difficulty of retrofit or upgrade

Electric baseboards can easily be upgraded or replaced. They also can be installed into an existing home, but care should be taken to place them out of the way of furniture and doors.

Advantages	Disadvantages
<ul style="list-style-type: none"> <li>• Electric baseboards have a low installation cost compared with other systems.</li> <li>• It is easy to install individual room thermostats so that heat can be turned down in rooms that are not being used.</li> <li>• Electric baseboards require very little maintenance.</li> <li>• Electric appliances have a high efficiency and no heat is lost up the chimney in the home.</li> <li>• A lack of combustion products results in clean and safe operation. They do not require venting.</li> </ul>	<ul style="list-style-type: none"> <li>• Electric baseboards can be very expensive to operate depending on the cost of electricity in a region.</li> <li>• The price of electricity is tied to the fuel used to produce electricity in an area: if electricity comes from a diesel generator, the price of electricity will be dependent on the price of diesel.</li> <li>• Electric heaters cannot be used in a power outage.</li> </ul>

## MASONRY HEATERS

### Fuel

Masonry heaters may use any type of firewood as fuel. However, using properly dried wood is advantageous because less heat is lost to boiling water stored in the wood. Burning trash and other non-wood substances in a masonry heater is not recommended. Garbage contains a wide variety of materials, including plastics and papers containing dye and ink. The smoke from these materials contains toxic chemicals that will damage your masonry heater.

Wood can be considered a renewable resource, because trees can be planted to provide more firewood in the future. It is also carbon dioxide (CO<sub>2</sub>) neutral because the CO<sub>2</sub> released from wood burning is about the same as the CO<sub>2</sub> that would be produced if the wood decomposed.

Wood is often sold by the cord. Many wood burners chop, split, and dry some or all of their own firewood. Hence the saying that wood has the advantage of heating twice: once when you do the hard work to gather and store it, and once when you burn it.

### Distribution System

Masonry heaters have been used in Northern Europe for thousands of years. While they have a firebox, they distribute heat differently than a wood stove, boiler, or furnace. Masonry heaters have a large mass (usually made of bricks or stone) to store and later release heat from the fire.



The Masonry Heater Association of North America homepage ([www.mha-net.org](http://www.mha-net.org)) contains information on masonry heaters, design plans, building code issues, and certified masonry installers.



Masonry heaters have a large thermal mass to store and release heat.

Masonry heaters use large thermal mass to provide zone heating. Heat from a hot fire that burns for a short time is transferred to the large mass, which is typically made of bricks or stones. The heat then travels slowly through the thermal mass by conduction and is released into the room.

Masonry heaters can also provide heat for a hydronic system, although this is less common than masonry heaters that only use a thermal mass. In this case, the masonry heater heats water that is distributed through the house with pipes.



Masonry heaters are very safe wood burning appliances. The thermal mass does not get too hot to touch, so the only part that can burn you is the door to the firebox. And because fires burn hot and fast, there is little risk of high quantities of dangerous exhaust gas being released into a home.

### How it Works

An intense fire is lit once or twice a day in the firebox. The fire burns hot, quickly, and efficient, so the wood burns cleanly and fewer particulates are emitted in the exhaust. The flue passage taking exhaust outside is carefully designed so exhaust gases travel through the thermal mass and release heat (whereas a traditional wood stove vents exhaust immediately). The heat that is stored in the thermal mass radiates out heat for hours.

Masonry heaters can be designed to heat an entire home or specific zones. They can also store heat from a passive solar system if exposed to sunlight in winter.

### Maintenance

Masonry heaters are designed to require little maintenance. Short-burning, hot fires release little creosote, so cleaning the flue is not required if the masonry heater is properly used. However, a yearly check by a maintenance professional will ensure the masonry heater is working as intended with little build-up in the flue. In addition, the ashtray should be cleaned out with each use.

### Efficiency Range

Masonry heaters have an efficiency of 65-85%. The efficiency of the masonry heater is dependent on the installation, because each masonry heater is unique. It is important to hire an experienced installer to design and build the masonry heater. More efficient masonry heaters deliver more heat from the fire to the house.

### Difficulty of retrofit or upgrade

Masonry heaters are best installed when a house is being built because they require an adequate space that can support their size and weight. Their design and installation takes time. Upgrades are not installed as a masonry heater is designed specific to the home and is built to last for thousands of firing cycles.

Advantages	Disadvantages
<ul style="list-style-type: none"> <li>• Masonry heaters burn more cleanly than other wood-burning appliances because the fire is hot and burns quickly.</li> <li>• Masonry stoves are very safe, because the thermal mass is never too hot to touch, and because a short burn time eliminates the possibility of being poisoned by exhaust gases in case of a malfunction.</li> <li>• Masonry heaters have small operation and maintenance costs.</li> <li>• No electricity is needed to run a masonry heater so they can be used in a power outage.</li> <li>• Gathering and cutting firewood is an enjoyable form of physical fitness for some.</li> </ul>	<ul style="list-style-type: none"> <li>• There is a high capital cost because the design and installation is specific to a home.</li> <li>• Masonry heaters are best-suited to energy-efficient homes of moderate size.</li> <li>• Masonry heaters do not produce immediate heat, instead providing warmth over several hours. It can take hours to heat up a cold room with a masonry heater. Similarly, masonry heaters take several hours to cool down, which could cause overheating in the fall or spring.</li> <li>• Masonry heaters should be installed by a certified installer. While certified installers are located in Alaska, they may not be available in most rural locations.</li> </ul>

## GROUND SOURCE HEAT PUMPS



Supply and return pipes connect a heat pump to the ground loop.

### Fuel

Ground source heat pumps (GSHPs) require electricity to run. Their main fuel, however, is geothermal. Heat pumps take heat from the ground and use electricity to “step up” the heat so it can be used for heating a home.

### Distribution System

Ground source heat pumps can provide either heated air or heated water. This means they can use a forced air distribution system or a hydronic distribution system.

### How it Works

Ground source heat pumps take heat from the soil underground, where the temperature is more constant year round than the outside air temperature. This heat is gathered by pumping fluid through loops of pipe located underground or in a body of water like a pond or lake. The loops can be arranged in horizontal trenches or in vertical wells.

After the fluid travels through the ground loop and gains heat, it enters the heat pump. The heat pump uses electricity to intensify the heat to a temperature useful for a heat distribution system. Heat pumps work like a food refrigerator in reverse. Instead of taking heat away from the interior and rejecting it outside, heat pumps gather heat from an outside source and “reject” it inside a home.

Heat pumps can be used as a primary or back-up heating system. They require a distribution system to deliver the heat they produce throughout the building.

GSHPs can provide both domestic hot water and space heating.

### Types of geothermal systems

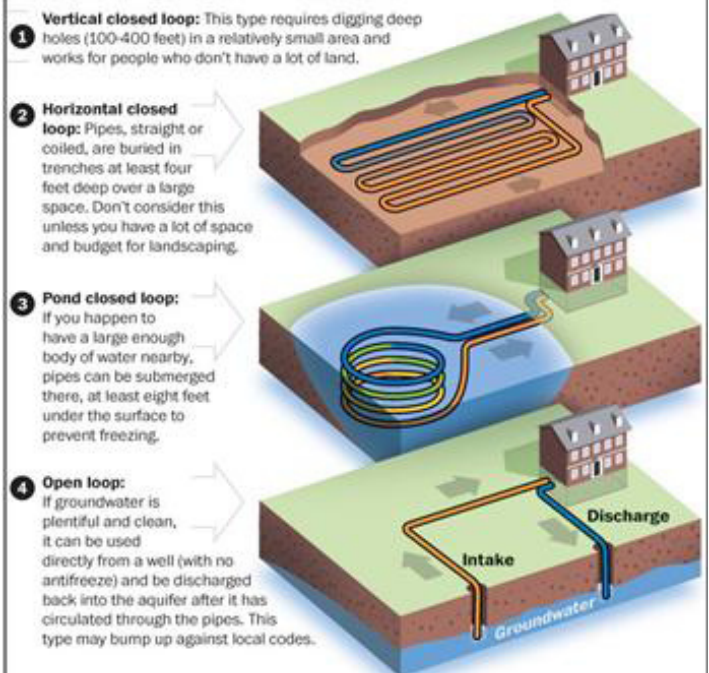

Figure from Bonnie Berkowitz and Laura Stanton, Washington Post.

## Maintenance

Heat pumps should be checked yearly by a heating professional, preferably before the heating season. They will check the condition of the heat pump and its connections.

They can adjust controls so that the heat pump operates efficiently. You can also inspect the heat pump regularly by following recommendations provided by the manufacturer. Look in the manual for tips on what to look for.

## Efficiency Range

The efficiency of heating GSHPs is measured by their coefficient of performance, or COP. Typically heat pumps have a COP in the range of 3-5. A higher COP means that the heat pump is more efficient and uses less electricity to transfer the geothermal heat into the building. Energy Star-rated heat pumps are more efficient than other options. Heat pumps that also provide cooling have different measures of efficiency.

The efficiency of the heat pump will also depend on local soil temperatures and indoor temperature, so it is important to talk to a contractor about whether a ground source heat pump is a good option for the soil near your house and your indoor heating needs. There are heat pumps made for colder soils such as those in Alaska.

## Difficulty of retrofit or upgrade

Heat pumps can easily be upgraded. Installing a heat pump into an existing home may be difficult because a ground loop must be installed outside the home. This requires excavation, and drilling, and finding space for the ground loop. However, because heat pumps use less electricity than an electric furnace or boiler, they are a good retrofit for houses with those appliances.



Time-delay relays and buffer tanks can be used with hydronic systems such as boilers, solar thermal systems, and ground source heat pumps. A buffer tank is a tank of water located between the heating appliance and the distribution system. The heating appliance heats the water in the buffer tank when its temperature drops to a set point. When a thermostat calls for heat in an area of a house, the hot water in the buffer tank will run through the system. If that is not sufficient, then the heating appliance will provide heat for the water in the tank.

A buffer tank is one way to achieve longer operating cycles which is more efficient than when a heating appliance has to cycle on and off frequently. Think of it as allowing the system to drive on the highway a few times a day instead of driving in stop-and-go traffic all the time. The buffer tank acts like a heat battery because it can accept heat from the appliance and then distribute it later as needed.

Advantages	Disadvantages
<ul style="list-style-type: none"> <li>Heat pumps are considered partially renewable, because the heat they take from the ground in the winter is replaced in the summer. They are entirely renewable if the electricity they use is from a renewable source.</li> <li>Heat pumps can also provide domestic hot water.</li> <li>A lack of combustion products results in clean and safe operation. They do not require venting.</li> <li>Some models of heat pumps can also provide cooling.</li> </ul>	<ul style="list-style-type: none"> <li>Ground source heat pumps are expensive to install compared with other systems, and require space for a ground loop. The installation will also require either drilling (for a vertical ground loop) or excavation (for a horizontal ground loop).</li> <li>Heat pumps are still relatively new to Alaska, so there are a limited number of installers.</li> <li>Heat pumps cannot be used during a power outage.</li> </ul>

## SOLAR THERMAL

### Fuel

Solar thermal systems (also referred to as active solar systems) collect heat from the sun's rays. The collectors for a solar thermal system should be located in an area that receives a lot of sun, such as a south-facing roof.

### Distribution System

Solar thermal systems heat water. They use a hydronic distribution system to deliver heat from the hot water to different areas in a home.

### How it Works

A solar thermal system involves collecting, storing, and using the sun's energy. Fluid inside the collectors carry the sun's heat to a storage tank and distribution system. The system is called "active" because electricity is needed to run pumps and fans to transfer the fluid.

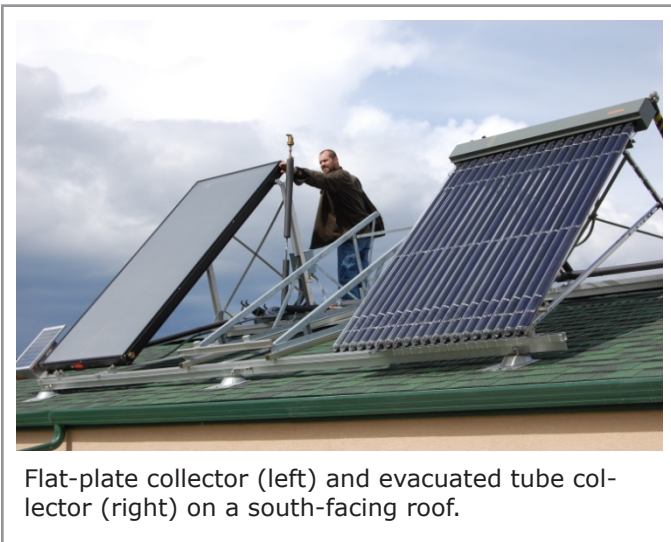

Flat-plate collector (left) and evacuated tube collector (right) on a south-facing roof.

Collectors should be located in a sunny area and are designed to absorb solar radiation. This heat is then transferred to a circulating fluid that travels between the collectors and a storage tank. In Alaska, this fluid should contain a chemical to prevent it from freezing, such as glycol.

The number and size of collectors is determined by the amount of solar radiation in the area, the collector efficiency, and the building's heat demand. Computer programs are available to help installers predict optimal sizing.

There are two main types of collectors. Flat-plate collectors are the most widely used and are both durable and effective. They also shed snow well if angled properly when

installed.

Evacuated tube collectors are constructed using several glass tubes. They are very efficient at absorbing heat. The disadvantage to these tubes is that they are more fragile than flat plate collectors, and generally more expensive.

Solar thermal systems can be integrated with another heating appliance, such as a furnace or boiler. This way they can provide renewable heat during seasons when sun is available but the home will be heated by the other appliance during the dark times of the year.





## Maintenance

Solar thermal systems should be checked yearly by a heating professional. They will check connections, fluid pressures, and system controls. You can also do periodic maintenance on the system. Check the manual to find out what you can inspect for problems. During snowy months, you may need to brush snow off the collectors.

## Efficiency Range

Solar collector efficiencies are given by conversion factor. The conversion factor is a number between zero and one that gives the efficiency of the collector. Higher conversion factors mean a collector is more efficient at absorbing the sun's energy. Collectors available today have conversion factors in the range 0.4 to 0.97 (a perfect collector has a conversion factor of 1).

The collector efficiencies will also depend on location, orientation, surface tilt angle, and the collector installation. So in addition to purchasing an efficient collector, it is important to install it correctly in a optimum location, so that it can reach its maximum efficiency.

## Difficulty of retrofit or upgrade

Solar thermal systems may be difficult to upgrade if the solar panels are located on the roof or a hard-to-reach exterior wall. Adding a solar thermal system to an existing home will depend on whether you have a good location to place collectors and your distribution system. If a home does not already have a hydronic distribution system, considerable construction may be required to install one.



Alaska Sun, [www.alaskasun.org](http://www.alaskasun.org), is a website for businesses, academics, and individuals who are interested in working toward a renewable energy future for Alaska. It contains educational materials, links to contractors, and Alaska-specific resources.

Advantages	Disadvantages
<ul style="list-style-type: none"> <li>• Solar thermal can be used for both space heating and domestic hot water. As hot water is needed year-round, even in the summer, solar thermal can be very effective for several months of the year.</li> <li>• Active solar systems can reduce dependence on fossil fuels and thus reduce heating costs.</li> <li>• Solar heating systems can be integrated with other heating systems to provide supplemental heat.</li> <li>• Solar thermal systems are safe when used correctly and require very little maintenance.</li> <li>• Solar thermal systems, when used properly, are very safe. They do not have combustion so there are no combustion by-products.</li> </ul>	<ul style="list-style-type: none"> <li>• For the majority of homes in Alaska, solar thermal cannot provide all of a building's year-round heating needs, as the greatest demand (in the winter) corresponds to the time of year with the least sunshine.</li> <li>• The collectors require a location with ample solar radiation (for example, a south-facing area of a roof).</li> <li>• Solar thermal systems require electricity for the pumps, so they cannot be used during a power outage.</li> </ul>

## PASSIVE SOLAR

### Fuel

Passive solar systems use energy from the sun's rays to provide heating.

### Distribution System

Passive solar systems use windows, orientation, and a large thermal mass to provide zone heating for a room. The thermal mass is usually made of a material like stone or brick.

### How it Works

Passive solar refers to a building design that collects, stores, and distributes solar energy during the winter and rejects excessive solar heat in the summer.



Sun filtering in through windows is one element of passive solar construction.

The design takes advantage of the local climate and conditions and consists of up to 5 elements. Simple passive solar may only use collectors while complex designs may incorporate all five strategies.

1. Collector: The collector typically consists of large, south-facing glass windows that allow sunlight to enter a building. [Alternate strategies may be a trombe wall or sunspace.]
2. Absorber: The surface of the thermal mass should be dark in color and sit in the sunlight. Sunlight that enters the collector hits the surface and is absorbed.
3. Thermal mass: The thermal mass stores heat. It is below or behind the absorber and usually consists of a material like stone or brick.
4. Distribution: The thermal mass distributes heat through conduction and radiation throughout the house. Heat travels through the thermal mass slowly by conduction and radiates from the surface of the thermal mass into a room.
5. Control: Roof overhangs, awnings, and blinds can be used to shade the collector and prevent overheating. Also, thermostats could control fans or vents to allow air flow.

In Alaska, complete passive design is not considered very practical because the amount of thermal mass needed is very large. However, houses with elements of passive design have been built throughout the state, as the collector portion of passive design can be very effective in a well-insulated house. If the builder is familiar with passive solar techniques, they can be added for little expense and provide substantial energy savings (Cooperative Extension Service, 2009).



Build It Solar ([www.builditsolar.com](http://www.builditsolar.com)) contains information and diagrams describing passive solar design. The website also contains resources for other solar projects.

### Maintenance

Passive solar systems require very little maintenance. Homeowners with a passive solar design need to make sure collectors such as windows are clean and that any awnings or blinds are in working order. More complex systems with elements such as automated shutters or fans require slightly more maintenance.

### Efficiency Range

The efficiency of passive solar systems is measured by the passive solar fraction. It is the fraction of the building heat load provided by passive solar design. It depends on the size of the collector and the size of the thermal mass and can range from 0 to 1. A passive solar fraction of 1 indicates that all of the space heating needs for the house are met by the passive solar system. A passive solar fraction of 0 indicates that there is no passive solar system. An efficient passive solar system will meet the fraction of heating needs that it was designed to provide.

Passive solar is typically not designed to provide all of a home's heat but simply to reduce the heat load provided by another heating device. It may not be desirable to have a passive solar fraction of 1, especially in Alaska where it would require a very large, heavy thermal mass. It is important to discuss your expectations for a passive solar system with your builder. A passive solar design that provides even 25% of the building heat load will save you one quarter of your annual heating costs each year.

### Difficulty of retrofit or upgrade

It is very difficult to retrofit passive solar design into a house as that would typically involve considerable construction.

Passive solar design is best incorporated into the original design.

Advantages	Disadvantages
<ul style="list-style-type: none"> <li>• Passive solar design can reduce the heating demand of a building.</li> <li>• After the initial cost, passive solar has little maintenance or upkeep costs.</li> <li>• Many aspects of passive solar design do not depend on electricity.</li> </ul>	<ul style="list-style-type: none"> <li>• As passive solar is a design, rather than an appliance, it is very difficult to retrofit into a home.</li> </ul>

## FORCED AIR DISTRIBUTION

### Distribution

Heat is distributed throughout a home by heated air that moves through ducts, and is delivered to rooms by air registers or grilles. Air registers and grilles are vents through which hot air is delivered to a room or cooler air is returned to the heating appliance. Typically, a register contains a damper to control the air flow through it and a grille does not, but the two terms are used interchangeably by many people.

### Heating Appliances

Forced air distribution systems can be used with heating appliances that produce heated air. Generally the air is 120°-150° F when leaving the heating appliance. Furnaces of any fuel type and ground source heat pumps can work with a forced air system. In addition, appliances such as boilers that produce heated water may be coupled with a forced air system, although this is less common. In this case, air is passed through coils of pipe filled with heated water.



Air ducts take heated air to and from a ground source heat pump.



An air register is an air vent used in a forced air system.

### How it Works

A forced air system uses ducts to transfer heated air to rooms through registers or grilles. After air is heated by the appliance, a blower sends it through the ducts. Return registers bring air back to the appliance.

Ducts are made from metal, fiberglass ductboard, or a product called flex-duct, which consists of flexible wire and plastic. Typically metal ducts need to be insulated, although insulation on all types of ducts will improve performance, especially if the duct runs through unconditioned space. The insulation prevents air in the ducts from losing heat before it reaches its destination.

Ducts are placed throughout a building to bring heated air from the heating appliance to all conditioned rooms. Each area of the building contains supply registers or grilles to distribute heated air and return registers or grilles to bring air back to the heating appliance. The volume and pressure of supply and return air should match. If they do not, some rooms will be over-pressurized, and others under-pressurized. Pressure differences can then impede the flow of air and make the system less efficient.

Supply registers should be sized to provide sufficient air to each room and placed in a location that facilitates proper air mixing. In cold climates, registers are often located on the floor near the perimeter of the house so that rising warm air will mix with cool air next to the wall.



It is of utmost importance to have a forced air system professionally installed, because air leaks in the ducts can make the system inefficient. In addition, leaky ducts can cause pressure imbalances in the home. If ducts run through a crawl space, pressure imbalances can introduce radon into the house.

Potential leak points, such as where the ducts connect, should be sealed with mastic or foil tape. Do NOT use duct tape, as it is not designed for sealing ducts and high heat can cause it to peel off.

## Layout Options

The size and layout of ducts is discussed in the Air Conditioning Contractors of America (ACCA) Manual D. Each room will have one supply and one return register, however, if air flow is permitted between rooms fewer registers may be required. There are multiple ways to configure ducts to reach each area of a building. In some cases, these methods are combined.

1. Trunk and branch: In this configuration, ducts to individual rooms branch off from a long central duct. The blower can either be located at the middle of the central duct or at one end.

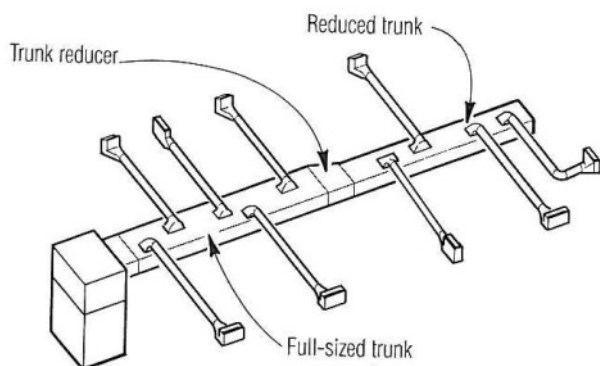

Trunk and Branch Ducts: Image from Journal of Light Construction, 2005.

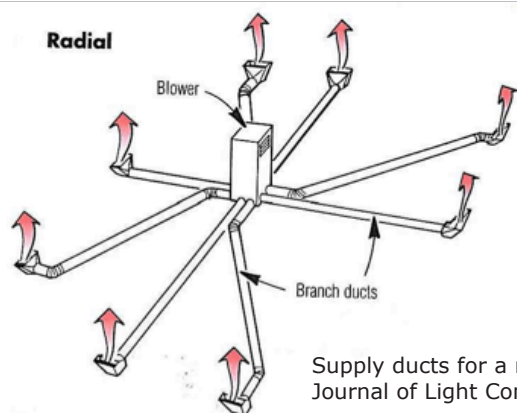
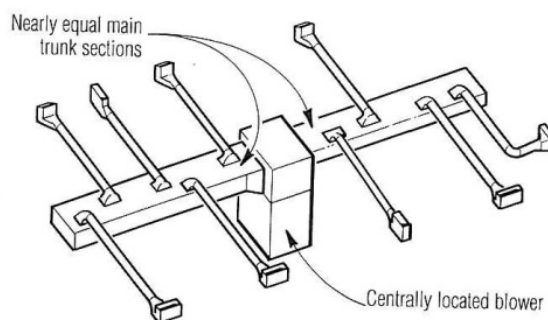

Supply ducts for a radial system. Image from Journal of Light Construction, 2005.

2. Radial systems: In this configuration individual ducts bring heat to rooms from a central blower. These systems are simple to install and are inexpensive.

3. Perimeter loop system: In this configuration a perimeter duct loop is installed in the outer wall of a building. These systems are more expensive to install, but are occasionally used in cold climates because they can warm the floor near cold walls.

**Maintenance**

Forced air systems should be checked yearly by a heating professional, who can usually check and tune the forced air system and heating appliance in the same visit. Expect them to check duct connections for leaks, clean the blower, and make sure the blower is working in conjunction with the heating appliance.

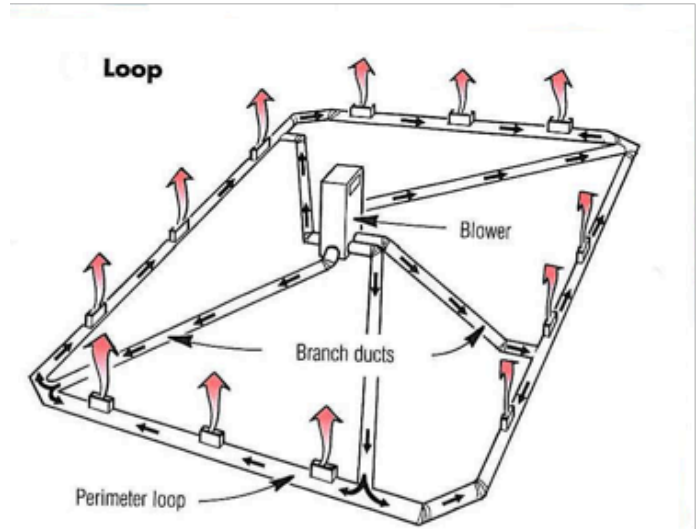

Supply ducts for a loop system. (Return ducts are not shown.)  
Image from Journal of Light Construction, 2005.

Depending on your forced air system, you may need to change the air filters. Dirty filters make the system less efficient because the blower has to work harder to send air through them. Check the manual for your heating appliance or talk to a contractor to find out how to change filters and how often you should check them.

Duct leakage is tested using a fog machine or calibrated fan. Ducts should be tested after installation to identify and seal leaks.

**Efficiency Range**

Ducts are 40-90% efficient in delivering heated air from a furnace to a building space. They have a wide range of efficiency due to factors like layout, insulation, and leaks.

Advantages	Disadvantages
<ul style="list-style-type: none"> <li>• Forced air systems have the ability to change the temperature of an area quickly.</li> <li>• They can be integrated with air filtration devices.</li> <li>• They can be used for cooling, ventilation, and humidification in addition to heating.</li> </ul>	<ul style="list-style-type: none"> <li>• Forced air systems can be noisy depending on duct layout and fans.</li> <li>• Ducts require a large amount of space and a large amount of energy to move air.</li> <li>• Duct systems are less efficient than hydronic systems and require higher output temperatures from heating appliances.</li> <li>• Fans moving air require more electricity than water circulating pumps in a hydronic system. If electricity rates in your area are high, this could impact your energy bills.</li> </ul>

## HYDRONIC DISTRIBUTION

### Distribution

Heat is distributed throughout a home by hot water or steam that is pumped through pipes. Heat is emitted to rooms by baseboards, radiators, or radiant floor slabs.

### Heating Appliances

Hydronic systems can be used with a heating appliance that produces steam or hot water. Baseboard or radiator systems can distribute steam or hot water while a radiant floor uses hot water only. Steam heat is much less common today and is less efficient than heating with hot water.

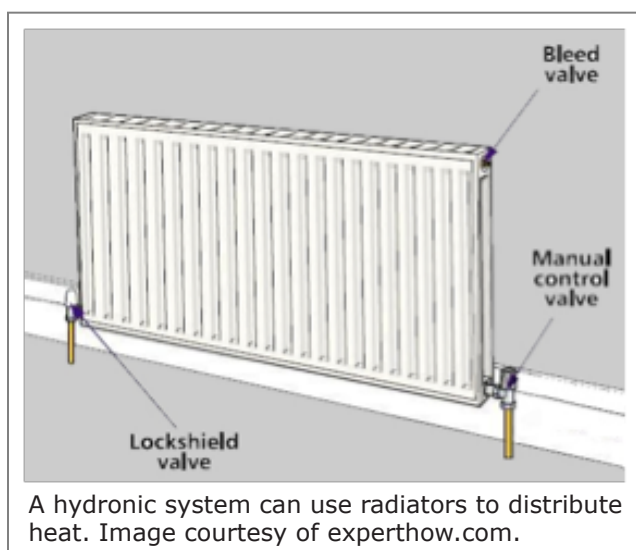
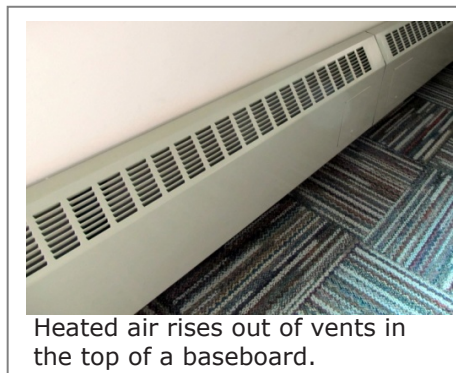

Steam is produced by a steam boiler. Hot water is produced by boilers, ground source heat pumps, and solar thermal systems. It can also be produced by a masonry heater, although this is less common.

### How it Works

Hydronic systems pump hot water or steam through pipes to baseboards, radiators or radiant floors located in rooms throughout a buildings.

**Baseboards and radiators:** Baseboards are heat emitters with finned tubes for hot water or steam to travel through. Cold air enters the baseboard through a vent in the bottom, gains heat from passing by the finned tubes, and rises out of a vent at the top. This process is known as passive convection: air

moves through the baseboard without the use of fans. For this process to work, baseboards require water with a temperature of 150°F – 180°F.

Radiators are heat emitters that have pipes for hot water or steam arranged in an upright metal structure. As the name implies, the metal heats up and radiates heat to the room. Heat also moves through the room by convection. Radiators require heated water to be between 120°F - 180°F.

Baseboards and radiators are usually located on the outside walls of rooms where rising warm air can counteract cool air next to the wall. This helps prevent window condensation by keeping windows warm. Additionally, it is important to place the heat emitters where they will not be blocked by furniture or door swings. It is also important to replace damaged baseboards and radiators and keep them clean. This helps improve their efficiency.



PEX tubing is laid out for radiant flooring before concrete is poured.

**Radiant Floors:** Hydronic radiant floor systems use hot water to transfer heat to rooms using radiation. Radiant floors have pipes running through the floor, under the floor surface. Hot water is pumped through the pipes where it transfers its heat to the floor material. The floor then radiates the heat into the room. Convection causes the warm air to rise in the room as well.

The water temperature in the pipes usually ranges between 90°-140°F, which produces a floor temperature of 85°-100°F, depending on the type of floor covering.

Radiant walls and ceilings are also possible because radiant heat travels in any direction. While not as common as a radiant floor, they can be very useful in remodels where it is impractical to add heat to the floor, or in rooms (such as a bathroom) where there is not enough usable floor space to provide adequate heat.

## Layout Options (baseboard and radiator)

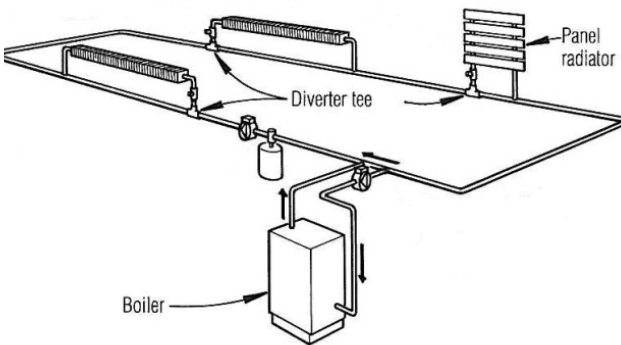

A one-pipe system with diverter tees. Image from Journal of Light Construction, 2005.

they receive. There is limited zone control in this layout, although controls on each heat emitter can allow occupants to adjust the temperature in a room.

2. One-pipe system with diverter tees: In this system each emitter is connected to the main loop by a diverter tee, which makes the system more flexible than a series loop. This layout allows for zoning as valves to the emitters can be adjusted manually or electronically.

The pipes for baseboards or radiators can be laid out in a number of different configurations:

1. Series loop: In a series loop, the heat emitters are connected in one common loop so that the water temperature decreases as it passes from one heat emitter to the next. Each heat emitter must be sized according the water temperature it receives, so the emitters near the end of the loop will be larger to account for the lower water temperature

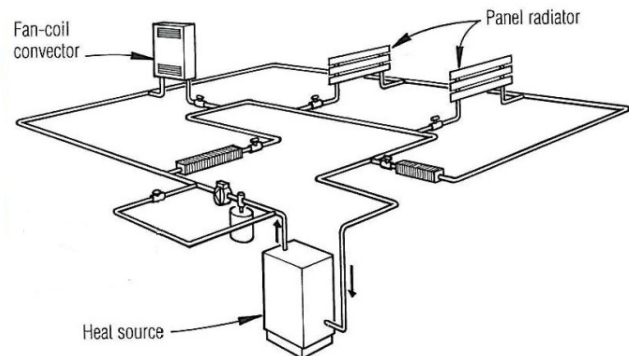

A two-pipe system has separate supply and return pipes. Image from Journal of Light Construction, 2005.



3. Two-pipe systems: The layout for a two-pipe system is similar to that of a one-pipe system, except that the return water from each emitter goes to a common return loop instead of re-entering the main loop and flowing to the next emitter (as in a one-pipe system). Because all emitters see the same entering water temperature, emitters farther away from the source do not need to be upsized. Since there is no progressive heat loss, these systems work well with appliances such as ground source heat pumps or condensing boilers that produce heated water with a lower temperature than other appliances.

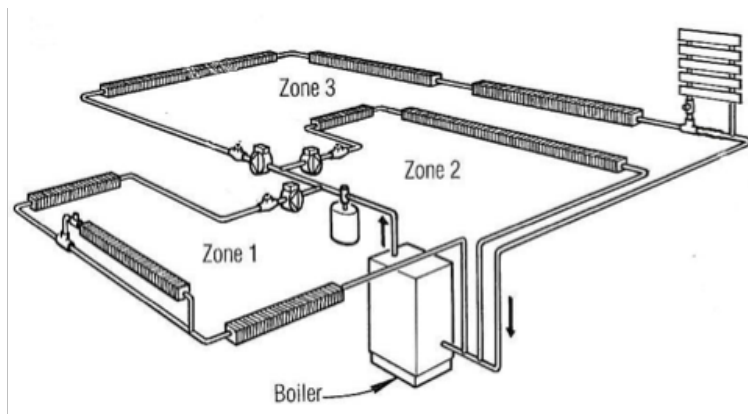

Multizone piped systems have multiple loops. Image from Journal of Light Construction, 2005.

4. Multi-zone system: In this layout, each zone has a separate piping circuit. Each zone can have its own circulating pump, so less power is used if only one zone is calling for heat. An advantage of this system is that a failure in one area, such as a leaky pipe or failed pump, will only affect one zone.

### Layout Options (radiant floors)

Care must be taken with the design of a radiant floor system. The layout of the pipes should have the pipes carrying the warmest water near exterior walls. Rooms with different floor coverings should be treated as different zones because they emit heat differently.

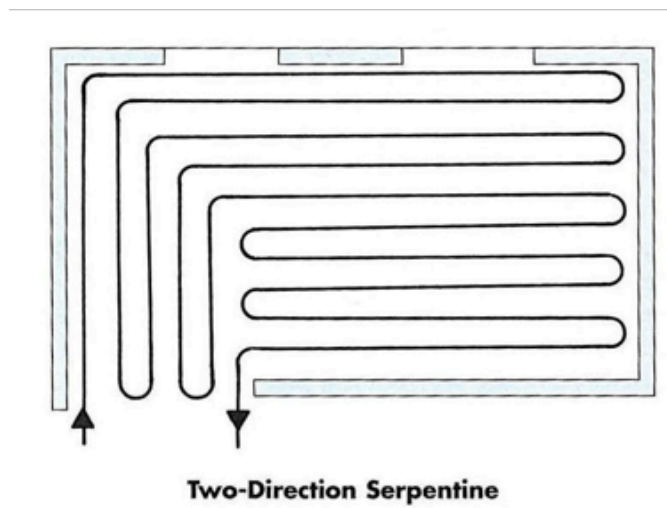
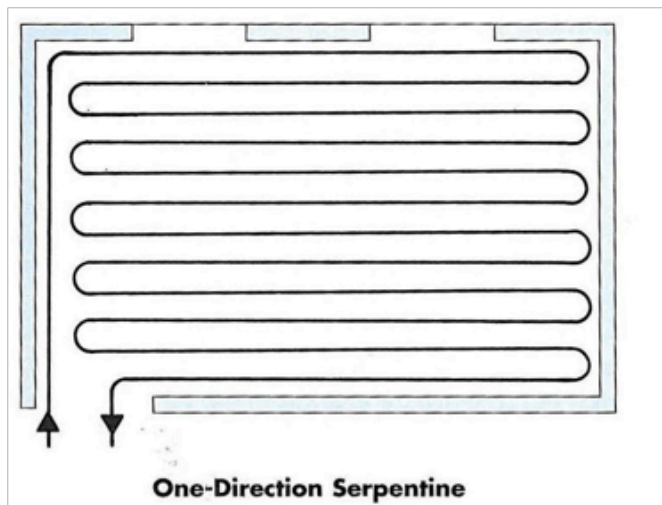

Two possible layouts for pipes in a radiant floor. Both have incoming water near outer walls. Image from Journal of Light Construction, 2005.

### Maintenance

Hydronic systems should be checked yearly by a heating and cooling professional. Usually, the hydronic system and heating appliance can be checked and tuned in the same visit. Expect them to inspect the pressure-relief valves, the pressure tank, and the heating appliance heat exchanger.

### Efficiency Range

Hydronic systems are 80-90% efficient in delivering heat from the heating appliance to rooms in a building. The overall efficiency will depend on the quality of the installation, the piping material, and the system configuration.



Checking the temperature of a radiant floor.



This "staple up" radiant floor system uses metal connectors to help distribute heat to the floor. View from basement.

Advantages	Disadvantages
<ul style="list-style-type: none"> <li>Hydronic systems do not require much energy to distribute heat to distant areas.</li> <li>They will make integration of domestic hot water and space heating easier.</li> <li>They are flexible: if a room requires heated air, the hot water can be passed through a heat exchanger to provide it.</li> <li>It is easier and more convenient to install zones with hydronic systems than with forced air.</li> <li>They have a smaller footprint in the home than forced air systems.</li> <li>The necessary water temperatures for radiant floors are lower than for baseboards or radiators. This allows for use of higher efficiency condensing boilers, ground source heat pumps, and solar thermal systems.</li> </ul>	<ul style="list-style-type: none"> <li>A leak in a hydronic system may be difficult to fix, depending on where it is located. Also, a leak can cause pressure imbalances in the pipes and damage walls and floors.</li> <li>The hot water must be protected from freezing (for example, by using a glycol solution instead of just water) in case of an extended power outage or a heating appliance breakdown.</li> <li>Installation cost for radiant floors is generally higher than for other systems.</li> <li>Controls are needed to prevent the heating appliance for a radiant floor from providing too much heat while the floor is gradually warming the room (this is known as the flywheel effect).</li> </ul>

## STORAGE WATER HEATERS

### Fuel

Storage Water Heaters, commonly called water heaters, can heat water using a variety of fuels, including natural gas, fuel oil, or propane. They can also use electricity or a solar thermal system to heat water without combustion. Whether or not the storage tank requires electricity for the controls depends on the model.

### How it Works

Water heaters offer a ready storage tank of hot water at all times. When hot water is needed at a faucet, it is released from the top of the tank and cold water enters the bottom of the tank. If enough hot water leaves the storage tank that the temperature of the remaining water falls to a pre-determined set point, controls cause a heating appliance to turn on.

Water can be heated by either a combustion heater (burning natural gas, fuel oil, or propane), an electric heating element, or a solar thermal system. The water temperature is controlled by the thermostat in the tank, which turns the heater on and off based on the temperature of the water.



A 120-gallon tank and a 50-gallon storage tank hold water.

### Sizing

It is important to purchase a properly sized storage tank. A tank that is too large will heat water unnecessarily and waste energy. A tank that is too small will run out of hot water and residents will have to wait for the heating element to heat water in the tank.

The size of a water tank is determined by its First Hour Rating, which is the amount of hot water in gallons the heater can supply per hour, assuming that it starts with a full tank of heated water. It is determined from the size of the water tank, the size of the heating element, and the heat source. The first hour rating is listed in the specifications for the storage tank.



- On a conventional hot water storage tank, you can lower the temperature of the water in your tank to save energy. Often the temperature is set higher than necessary, which requires extra energy. A temperature of 120°F is sufficient to stop bacteria growth, mineral buildup, and corrosion while still providing adequate hot water to your home. If you don't want to lower it all the time, consider lowering it when you're gone more than 3 days. Consult the tank manual to learn how to lower the water temperature.
- You can insulate your domestic hot water tank with a pre-cut blanket or jacket, especially if it is located in an unheated area. The extra insulation will slow the heat loss from the tank and save money. Jackets are available at local hardware stores and are safe to add to water heaters that do not use natural gas. If you have a natural gas storage tank, hire a professional to install the blanket to ensure it does not interfere with the flame. You can also insulate hot water pipes with insulating sleeves.

The first hour rating should be within a few gallons of a building’s peak hourly demand. For a household with 3 occupants that routinely shower in the evening while running a dishwasher, the peak hourly demand might be around 45 gallons. This house would need a storage water heater with a First Hour Rating of 40-50 gallons. You can calculate your peak hourly demand at the Energy Saver’s website on hot water heaters: <http://1.usa.gov/pLDv5V>.

### Maintenance

Storage tanks should have a yearly check-up, which a heating contractor can usually do when they come to do maintenance on your heating system. The heating contractor might flush the system during the check-up to get rid of sediment and check for rust. They will also check for leaks at pressure-relief valves. Also, it is always a good idea to read the appliance manual for regular home maintenance and care.

### Efficiency Range

Hot water heaters are rated by Energy Factors, their average efficiency over a 24-hour period. A higher energy factor means that the water heater is more efficient. Energy factors for water heaters can range from 60–90% [sometimes reported as 0.6 to 0.9]. Energy Star-rated water heaters are more efficient than standard models. For example, conventional storage water heaters that use natural gas must have an energy factor of 0.67 to qualify for an Energy Star rating. If a gas-fired heater uses condensing technology, it must have an energy factor of 0.8 to qualify for Energy Star status.

Water heaters lose heat in two ways: through tank walls and through the exhaust. Hot water sitting in the storage tank will lose heat to the room through the tank walls. This is called standby loss, and amounts to lost energy and money. For instance, a lot of energy is wasted in a situation where a family only uses hot water for showers in the morning and cooking in the evening. The storage tank must keep water heated during the day and night when the water isn’t being used. To minimize the amount of standby loss, the water storage tank should be insulated and located in a heated area, such as a closet or basement. If you are not going to be using hot water throughout the day, consider paying more for a better-insulated tank.

Combustion water heaters require a vent for combustion gases to exit so exhaust does not enter a home. Heat is also lost “up the chimney” when it is lost up the vent. Electric water heaters and solar thermal systems do not lose heat this way, because they do not require a vent for exhaust.

Advantages	Disadvantages
<ul style="list-style-type: none"> <li>• There is a steady supply of hot water at all times.</li> <li>• Well-insulated tanks can have high energy factors.</li> <li>• Storage water heaters generally are inexpensive and straightforward to buy and install, or to replace.</li> <li>• Hot water heaters can work with recirculating hot water systems.</li> <li>• Water heaters that do not require electricity can still provide hot water in a power outage.</li> </ul>	<ul style="list-style-type: none"> <li>• There is standby heat loss from all storage water heaters.</li> <li>• Gas and oil-fired heaters require a vent and have venting-related heat losses.</li> <li>• Tanks are large and heavy.</li> <li>• If there are guests in the home or the demand for hot water increases, the tank can run out of hot water.</li> </ul>

## TANKLESS WATER HEATERS

### Fuel

Tankless water heaters are typically fueled by natural gas or propane, but some models use electricity to heat water. The majority of models require electricity for the controls.

### How it Works

Tankless hot water systems provide hot water only when it is needed. When a hot water tap is turned on, cold water travels through a tankless heating unit on its way to the faucet. The water is heated either by electricity or by combustion—natural gas or propane. Most tankless water heaters can provide hot water at the rate of 2-5 gallons per minute. Buildings requiring more hot water can install multiple tankless heaters.



To ensure that they do not heat water above a safe temperature, tankless coils require a minimum flow rate to fire and they will only fire if the water temperature is in a set range. Sometimes this means increasing the flow rate to receive hot water. It can also mean that if the entering water temperature is above the set range, it won't be heated and will feel colder than the hot water normally provided.

### Sizing

It is difficult to properly size and install tankless water heaters because the size of the heater must take into account the peak hot water demand of the house, the temperature of the incoming water and the flow rate of the water.

To calculate your peak hot water demand, it is important to know the maximum number of gallons of hot water per minute you will need. As there is no storage tank to draw from, the tankless heater must be able to supply enough heat for all faucets that are on at any given time. This may require installing a larger tankless heater to provide sufficient hot water when several gallons of hot water are required per minute. To calculate your peak hot water demand, add up the flows of the appliances that are likely to run at the same time. Some average flows, given in gallons per minute, are in the table on the next page. For example, if you want to be able to run the dishwasher (1.5 gallons per minute) while 2 people are in the shower (2.5 + 2.5 gallons per minute), you need a tankless heater capable of providing at least 6.5 gallons per minute.



In Alaska, the incoming water supply is generally colder than in the lower 48. If the heater is not sized correctly, it will not be capable of sufficiently heating the colder water as it flows through. If you plan to install a tankless system, make sure you hire an experienced contractor who has an established method for determining the size of the heater and who is familiar with the temperature of the incoming water in your area.

Use this table to figure out your maximum gallons per minute.

Appliance	Approximate gallons per minute
Low-flow faucet	0.5-1.5
Dishwasher	1.5
Shower	2.5
Clothes washer	4
Bathtub	2-4

**Maintenance** Other than a yearly check-up, which a heating professional can usually do while servicing your heating system, tankless water heaters require very little maintenance. However, it is always a good idea to read the owner’s manual for regular maintenance and care instructions.

**Efficiency Range** Hot water heaters are rated by their Energy Factors, their average efficiency over a 24-hour period. Higher energy factors mean that the water heater is more efficient. The energy factors of tankless water heaters range from 70–90% (sometimes reported as .7 to .9) Tankless water heaters rated by Energy Star are more efficient, with an energy factor of .82 or higher.

Tankless heaters do not have standby losses, but they can still lose heat “up the chimney” as heat is lost when exhaust gases go up the vent. Tankless heaters can also be more expensive to run because they are capable of producing endless amounts of hot water at a time. It is important not to let the possibility of never-ending hot water change your usage habits if you want to benefit from the potential cost-savings this system offers.



For hydronic space heating and hot water systems, you can insulate the water pipes with pipe insulation wrap or pipe sleeves from a local hardware store. This will reduce the amount of heat the hot water loses to the air on its way to the distribution system or faucet. Pipe insulation is easy to install, but follow directions and keep insulation away from the flue or chimney, which should NOT be insulated after installation.

Advantages	Disadvantages
<ul style="list-style-type: none"> <li>• There is no standby loss associated with tankless hot water heaters because they run only when needed.</li> <li>• Tankless systems have a longer life span than conventional water storage units (U.S. Department of Energy, 2011).</li> <li>• Tankless hot water systems can be used as a booster for a solar hot water heating system.</li> <li>• Tankless systems can provide “endless” hot water because there is no need to wait for a tank of water to heat up.</li> <li>• Tankless systems are space-savers because there is no large storage tank.</li> </ul>	<ul style="list-style-type: none"> <li>• The initial cost is usually more than a conventional storage hot water system.</li> <li>• Tankless systems can result in inconsistencies in water temperature and intermittent delivery.</li> <li>• Most tankless systems require electricity to operate.</li> <li>• Most tankless systems do not work with recirculating hot water systems.</li> </ul>

## COMBINED/INTEGRATED SYSTEMS

### Fuel

Combined or integrated systems consist of appliances that produce hot water for both space heating and domestic uses. Hot water used for space heating goes into a hydronic distribution system or to coils to produce heated air for forced air distribution, and domestic hot water goes to a storage tank or to the faucet. The fuel used to power the heating appliance depends on which heating appliance you are using.

### How it Works

The most common design for a combined system is for the heating appliance to heat water in an attached storage tank. For instance, a boiler, ground source heat pump, or solar thermal system may heat water in an attached storage tank as well as provide space heating. However, there are also tankless options that provide instantaneous hot water. In this case, the heating appliance fires when a faucet calls for hot water.

Systems with a storage tank are called “indirect” water heaters. The appliance sees the hot water tank as a different zone than the space heating system. When the domestic hot water tank needs heat, the appliance provides heat to that zone. The storage tank allows the appliance to only fire a few times a day for hot water. In the summer, indirect systems are more efficient than tankless coil combined systems because the appliance does not have to fire as frequently.

The other type of combined system is referred to as a tankless coil system. These combined systems feature an extra heat exchanger that fits into the appliance. Water is heated when it flows through the heat exchanger. Tankless coil systems can be very efficient when the appliance is being used for space heating, but in the summer months the on-off cycling that occurs every time domestic hot water is needed can waste energy. One option is to use a tankless coil during the winter and a separate domestic hot water system during the summer.



This boiler has separate pipes for hydronic distribution and domestic hot water.



With conventional storage tanks, you have to take care that installing extra insulation does not interfere with the burner.

One advantage of an indirect water system is that there is no burner on the storage tank (as in a conventional, stand-alone tank) so you can put extra insulation on the tank to save energy.



The more interested reader can consult a Brookhaven National Laboratory study on the efficiency of integrated systems with boilers: Butcher, T. (2007) Performance of Integrated Hydronic Heating Systems. Brookhaven National Laboratory, New York.

Ground source heat pumps can also come with a “desuperheater” or a component that allows a heat pump to provide domestic hot water. These systems work differently than other integrated systems because heat pumps are not combustion heaters. In the winter, the desuperheater uses heat from the compressor in the heat pump to provide hot water. In the summer, heat pumps can run in cooling mode, rejecting heat to the ground. In this case the desuperheater can divert some of this heat to the domestic hot water system.

### Sizing

If you would like your heating appliance to provide domestic hot water, it must be sized correctly to do so. Your contractor will size the appliance to provide both space heating and domestic hot water.

### Maintenance

As integrated systems combine domestic hot water and space heating into one appliance, it is easy to have a heating contractor do the yearly maintenance for both parts of the appliance at the same time. Otherwise, check the manual for regular maintenance and care instructions to keep the appliance working in good condition.

### Efficiency Range

Heating appliances are rated by different efficiencies. However, these efficiencies apply to space heating only. A higher efficiency (for example, a higher AFUE for a boiler) does not necessarily mean that the appliance will be more efficient providing space heating and domestic hot water. To learn the actual efficiency, try speaking with a heating contractor and other customers that have experience with the same appliance.

Advantages	Disadvantages
<ul style="list-style-type: none"> <li>• With an integrated system there are fewer appliances to maintain, since the system provides both domestic hot water and space heating.</li> <li>• During heating season, it is more efficient to have a single appliance provide both hot water and space heating.</li> <li>• An integrated system saves space.</li> <li>• The maintenance for both appliances can be combined.</li> <li>• This type of system can be used during the winter and paired with a different hot water system for summer use.</li> </ul>	<ul style="list-style-type: none"> <li>• Tankless coil systems are not efficient when the heating appliance only fires occasionally (such as during the summer to provide domestic hot water).</li> <li>• AFUE is not a good indication of how efficient an integrated system will be. It is important to talk to a contractor about the efficiency of an integrated system.</li> </ul>



# For More Information

Alaska Housing Finance Corporation (AHFC) [www.ahfc.us](http://www.ahfc.us)  
and the AHFC Research Information Center (RIC) [www.ahfc.state.ak.us/energy/ric.cfm](http://www.ahfc.state.ak.us/energy/ric.cfm)



AHFC funded the creation of this consumer guide. In keeping with its mission of providing Alaskans with access to safe, quality and affordable housing, the organization provides many educational resources. They sponsor workshops and classes, and also have a number of references, including manuals, videos, and factsheets on housing and energy topics available in their RIC library. The RIC library is a building science library located in Anchorage and is open for scheduled appointments. In addition, much of the information is available on the web and accessible through the search function on the RIC website.

**Cold Climate Housing Research Center (CCHRC)** [www.cchrc.org](http://www.cchrc.org)

CCHRC is a research facility located in Fairbanks that promotes sustainable housing in the North. Its website contains basic information on heating systems and answers to frequently asked questions on different aspects of cold climate building. The organization regularly publishes reports on research and product testing projects that often deal with heating systems. These reports are available on the website at [www.cchrc.org](http://www.cchrc.org), through the blog at [makinghouses-work.cchrc.org](http://makinghouses-work.cchrc.org), and in the CCHRC library at 1000 Fairbanks Street in Fairbanks.



**Alaska Building Science Network (ABSN)** [www.absn.com](http://www.absn.com)

The Alaska Building Science Network (ABSN) website has various resources for homeowners, including information about home energy rebates, factsheets on home building topics, educational resources, and information on Alaskan building programs.



**Alaska Craftsman Home Program** [www.achpalaska.com](http://www.achpalaska.com)



The Alaska Craftsman Home Program, Inc. is an educational building industry alliance that offers consumer classes and professional workshops. Its website provides class schedules and a blog where the public can ask questions to building experts.

**AK Energy Efficiency: Solutions for Alaska** [www.akenergyefficiency.org](http://www.akenergyefficiency.org)

This website focuses on bringing resources to professionals, educators, students, and consumers. It has information on classes, energy-saving tips and Alaska-specific programs to help citizens become more energy efficient.



**UAF Cooperative Extension Service** [www.uaf.edu/ces](http://www.uaf.edu/ces)



The Cooperative Extension Service presents university research-based knowledge to Alaskans in an understandable and usable form. Extension educators are located throughout Alaska, and many of their publications are free and available online. Information on and publications from their Energy and Housing Program are available on the website.

**U.S. Department of Energy: Energy Savers** [www.energysavers.gov](http://www.energysavers.gov)

The U.S. Department of Energy maintains an Energy Savers website that focuses on energy efficiency and renewable energy. It has a section on “Your Home” with information on space heating and cooling and other aspects of buildings from electronics to windows. The website also has information on saving energy outside the home and provides links to additional resources.



**Energy Star** [www.energystar.gov](http://www.energystar.gov)



Energy Star is a joint program of the U.S. Environmental Protection Agency and the U.S. Department of Energy. It rates appliances, homes, and buildings that meet strict energy efficiency guidelines. Lists of Energy Star products and other resources are available on the website.

**Consortium for Energy Efficiency** [www.cee1.org](http://www.cee1.org)

The Consortium for Energy Efficiency has established tiers of efficiency for appliances used in homes and buildings, which are meant to complement the ENERGY STAR rating. The higher the tier, the more efficient the appliance is. The CEE website contains a listing of products and their tiers. Appliances are ranked in several categories, including HVAC. While not all heating appliances are on the website, it is a good resource to check when shopping for a heating system.



**American Council for an Energy-Efficient Economy (ACEEE)** [www.aceee.org](http://www.aceee.org)



The ACEEE is a nonprofit organization dedicated to advancing energy efficiency as a means of promoting economic prosperity, energy security, and environmental protection. Its Consumer Resources page provides tips on replacing heating systems, finding contractors, and improving the performance of your current system.

**Air-Conditioning, Heating and Refrigeration Institute (AHRI)** [www.ahrinet.org](http://www.ahrinet.org)

The AHRI website has a lot of information for consumers, including information on federal tax credits, how appliances work, and ways to save energy. In addition, AHRI maintains a searchable directory of performance certifications for HVAC equipment and components.



# Glossary

**Active Solar:** Active solar systems gather heat from the sun using collector panels. This heat is transferred to water in a storage tank by means of a circulating fluid. The heated water can be used for a domestic hot water system or for a hydronic distribution system. Active solar systems are also called solar thermal systems.

**AHRI Certificate:** The Air-Conditioning, Heating and Refrigeration Institute (AHRI) maintains a directory of certified product performance. Products in the directory have manufacturer performance numbers that have been independently measured and verified by AHRI. You can visit the directory to find appliances with AHRI Certificates or to verify that a product's certificate is authentic. It is located at [www.ahridirectory.org](http://www.ahridirectory.org).

**Air Conditioning Contractors of America (ACCA):** ACCA is a non-profit association serving the Heating, Ventilation and Air Conditioning community. They work to promote professional contracting, energy efficiency and healthy indoor environments. They maintain and provide technical, legal, and marketing resources to the industry which include manuals that set the standards for HVAC installations.

**AKWarm:** AKWarm is a software application maintained by the Alaska Housing Finance Corporation that is used for energy efficient design, retrofits, and to determine energy ratings. It has been tested and approved by the U.S. Department of Energy.

**Annual Fuel Utilization Efficiency (AFUE):** The AFUE is the common measure of efficiency for combustion heaters such as furnaces and boilers. It is the ratio of the heat that a heating appliance delivers to a building compared to the heat content of the fuel used in a heating season. A higher AFUE means that an appliance is more efficient and that less heat is lost "up the stack."

For example, a mid-efficiency natural gas furnace may have an AFUE of 80%. This means that the furnace delivers 80% of the heat available from the natural gas to the building. The remaining 20% of the natural gas heating potential is lost due to inefficiencies in the furnace. Such inefficiencies include on/off cycling, heat lost up the chimney, and standby losses.

Because the AFUE rating accounts for inefficiencies that happen in normal operation, it will always be lower than the rated combustion efficiency or rated steady state efficiency of an appliance. However, all three efficiencies are dependent on the quality of the installation and operating conditions. You can think of AFUE like the miles per gallon a car gets driving in stop-and-go city traffic, while steady state efficiency is like the miles per gallon a car would get driving on the highway. For this reason, it is important to compare the AFUE of appliances when making a decision on which one to purchase.

AFUE does not measure the overall efficiency of a combined system that provides both space heating and domestic hot water (DHW). Losses from idling in combined systems can vary, so looking at the AFUE alone will not give a complete picture of the combined system efficiency. Instead, if you are looking to buy a combined system, you should look for one with low idle losses and an advanced control system that will help to reduce the time the heating appliance operates below full capacity (Butcher, 2007).

**Aquastat:** Aquastats control water temperature in boilers and other hydronic heating systems. They are usually set to have a high limit temperature and a low limit temperature. If the heating appliance causes the water to reach the high limit temperature, they will shut off the heating appliance. Also, if water reaches the low limit temperature, they will cause the heating appliance to fire to raise the water temperature. A modulating aquastat will vary the temperature that the water is heated to based on the outdoor temperature to save energy during the shoulder seasons (fall and spring).

**Backdraft:** Backdraft describes the pulling of exhaust gases back through the flue into the heating appliance. From there the exhaust gases can enter the living space. This is problematic for the appliance and dangerous to human health, especially if the heating appliance is located in an unvented area. Backdraft can be deadly, because the exhaust gases contain carbon monoxide (CO) gas, which is poisonous and has no smell.

**Baseboard:** Baseboards are long heat emitters located along the bottom of walls. They draw in unheated air through a bottom vent and distribute heated air by convection as it rises out the top of the baseboard. There are 2 types of baseboards. Electric baseboards provide heat by means of electric resistance heating. Hydronic baseboards are used with heating appliances that produce heated water. These baseboards have pipes that run hot water through the baseboard.

**(BEES) Alaska Building Energy Efficiency Standards:** BEES is established by the Alaska Housing Finance Corporation through Alaska-specific amendments to the building standards of the 2009 International Energy Conservation Code. Included standards for thermal resistance, air leakage, moisture protection, and ventilation. Buildings that conform to BEES meet these building standards.

**Blower:** A blower is a large fan used in forced air heating systems. It sends heated air from a furnace through ducts to be distributed to rooms.

**Boiler:** A boiler is a heating appliance that produces heated water or steam that is delivered to a house by a hydronic distribution system. A boiler can use electricity or combustion from burning fuel oil, natural gas, or wood to heat water.

**British Thermal Unit (BTU):** A BTU is the amount of energy required to raise the temperature of one pound of water by one degree Fahrenheit. It is used as a unit for measuring heat. You can think of one BTU as roughly the same as the amount of heat that comes from burning one kitchen match. A boiler for a well-insulated 2-story house might be able to output 60,000 BTUs per hour.



The average BTU content of common fuels is listed in the following table. These are the same values that are currently used in AKWarm energy rating software. Keep in mind that the BTU content of fuels varies with fuel composition. This is most dramatic for wood and coal. For instance, different species of wood and wood with different moisture contents have different BTU levels. So the values in the table represent the average BTU content of a type of fuel. You can use the table to get an idea of the BTU content of the fuel you use, but it won't give the exact value.

Fuel	Average BTU Content (AKWarm, 1996)
1 kWh of electricity	3,413
1 Therm of natural gas	100,000
1 Gallon of propane	91,800
1 Gallon of fuel oil no. 2	138,000
1 Gallon of fuel oil no. 1 (kerosene)	132,000
1 Cord of air-dried Birch Wood	26,200,000
1 Cord of air-dried Spruce Wood	18,100,000
1 Ton of Coal	15,600,000

**Buffer Tank:** A buffer tank is a tank of water located between a hydronic heating appliance and its distribution system. The distribution system draws hot water from the buffer tank when an area in the home is calling for heat, rather than causing the heating appliance to fire. The heating appliance fires to heat the water in the buffer tank when its temperature drops to a set point. A buffer tank acts as a heat “battery” because it can accept heat and distribute it at a later time. It thus allows the heating appliance to avoid frequent and inefficient on and off cycling.

**Building Envelope:** The building envelope separates the inside of the building from the outside and provides support to the structure. It consists of the foundation, walls, doors, windows, and roof. In some places it is the same as the building’s thermal envelope but may differ if the main thermal insulation is in the attic floor, and the building’s actual roof is located well above that.

**Building Heat Load:** The building heat load is the rate at which heat must be added to a building to maintain the desired temperature.

**Carbon Monoxide (CO):** Carbon monoxide is an odorless, colorless gas that can be deadly. Over 400 Americans die each year from CO poisoning and more than 20,000 Americans go to the emergency room because of CO (Center for Disease Control and Prevention, 2009). Carbon monoxide is especially dangerous because humans cannot detect it. It is produced by the incomplete combustion of fuels, including wood, coal, fuel oil, and natural gas. Thus, CO is produced by all combustion appliances including space heating appliances, appliances with internal combustion engines, and portable generators. Low to moderate quantities can cause headaches, fatigue, or nausea. Long exposure or large dosage exposure can result in confusion, vomiting, impaired vision, and death. To prevent CO poisoning, heating appliances should be inspected and serviced annually and internal combustion engines should not be operated in an enclosed space (such as a garage).

CO detectors are available for around \$50 in hardware and department stores. Installing and maintaining them can save a life! For more information on carbon monoxide, please visit the Center for Disease Control and Prevention ([www.cdc.gov](http://www.cdc.gov)), the Environmental Protection Agency ([www.epa.gov](http://www.epa.gov)) and the Consumer Product Safety Commission ([www.cpsc.gov](http://www.cpsc.gov)).

**Chimney:** A chimney is a masonry or metal structure that contains one or more flues to vent combustion air.

**Combined System:** A combined system is a heating system that uses one appliance to provide heat for both space heating and domestic hot water. A combined system is also called an integrated system.

**Combustion:** Combustion, or burning, is a chemical reaction between a fuel and an oxidant (usually oxygen) which results in the production of heat and the conversion of chemicals.

**Combustion Efficiency:** Combustion efficiency refers to how effective a combustion appliance is in converting the chemical energy in fuel to heat. Combustion efficiency is typically quite high in furnaces and boilers (usually above 85%). This means that almost all of the chemical energy in fuel is converted into heat. Because combustion efficiency only measures how well an appliance converts fuel to heat, an appliance's rated combustion efficiency will always be higher than AFUE. To get a good idea of how efficient an appliance will be over the course of a heating season, you should look at combustion efficiency and AFUE.

Combustion efficiency can be tested by a heating professional. This test can show if the heating appliance is installed properly and if it is reaching its maximum combustion and seasonal efficiencies. To evaluate the combustion efficiency a heating professional can test:

- The flue temperature (too high indicates heat is being lost up the flue)
- Carbon dioxide (CO<sub>2</sub>) and carbon monoxide (CO) content of exhaust (too little CO<sub>2</sub> and CO indicates incomplete combustion)
- Smoke (smoke indicates incomplete combustion).

**Compressor:** A compressor is a small machine that lowers the volume and raises the temperature of a gas.

**Condensate:** The condensate is the liquid that is formed when vapor condenses.

**Condensation:** Condensation refers to the process by which vapor turns into a liquid. Heat is released during the change.

**Conduction:** Conduction is one of the three methods of heat transfer (see also Convection and Radiation). Heat is transferred between solid materials in direct contact by means of conduction. For example, when you touch a hot pan heat is transferred to your hand by conduction.

**Convection:** Convection is one of the three methods of heat transfer (see also Conduction and Radiation). Heat is transferred by convection by liquid or gas movement. Convection does not occur in solids. For example, if you place your hand above a candle, you can feel heat as air heated by the flame rises.

**Conversion Factor** Conversion factors are used to measure solar collector efficiency. Solar collector efficiency is a ratio of usable thermal energy to received solar energy. It measures how much solar energy enters the collector and is absorbed. A higher conversion factor means a solar collector is more efficient. A perfect solar collector would have a conversion factor of 1, which corresponds to an efficiency of 100%. A mid-efficiency flat plate solar collector used in a solar thermal system might have a conversion factor of 0.5.

**(COP) Coefficient of Performance:** The COP is a measure of efficiency for ground source heat pumps (GSHP). Heat pumps do not convert fuel to heat, so AFUE is not used to rate their efficiency. Instead, they use electricity to lift the temperature of a heat source (for instance, fluid coming from a ground loop) to a higher temperature that can be used for space heating. The COP is the ratio of heat output to work supplied to the system in the form of electricity.

$$COP = \frac{\text{Heat delivered to building}}{\text{Electrical energy used by GSHP}}$$

A typical COP for a heat pump system is in the range of 2 to 4, which corresponds to an “efficiency” of 200-400%. A higher COP indicates a more efficient heat pump.

**Cord:** A cord of wood is a 128-cubic-foot volume of wood. The wood should be arranged so the pieces are parallel, touching and compact so that you can estimate its volume. A typical cord of wood is stacked 4-foot-by-8-foot-by-4-foot, which includes both wood and airspace.

**Damper:** In space heating, a damper refers to a device that regulates airflow. Dampers are often located in flues and chimneys. They can be closed when the heating appliance is not in use to prevent heated air from escaping up the chimney, and opened when the heating appliance is firing, to allow exhaust gases to exit.



**Design Temperature:** Technically, the heating design temperature is the temperature at which 99% of the time during one year the outside temperature is above that point. For example, in Fairbanks, the design temperature is approximately -50°F, meaning that 99% of the time, the outside temperature in Fairbanks is above -50°F.

A good approximation is to think of the design temperature as the temperature on the coldest day of the year.

**Direct Vent:** Direct vent heating appliances have pipes for both incoming combustion air and exhaust gases. Both pipes lead to the outdoors so indoor air is not used in the combustion process.

**Domestic Hot Water (DHW):** Domestic hot water refers to the hot water used by a household that is produced by a domestic hot water heating appliance. It includes hot water needed for showers, faucets, dishwashers, clothes washers and other appliances.

**Downtime Losses:** Downtime losses occur when a heating appliance, such as a furnace or boiler, isn't running. For instance, when a boiler shuts off, the heat in the boiler continues to radiate out through the boiler and this heat is considered "lost" as it does not go to the distribution system. When the boiler turns back on, it has to re-heat water back to the operating temperature and, in some cases, reheat chimney air to provide proper draft.

Downtime losses occur for all appliances, and are the reason that the seasonal efficiency is less than the steady state efficiency.

**Draft:** Draft is the slight vacuum that exists in combustion heating appliances. It is caused by hot exhaust gases rising out of the flue, which causes supply air to be drawn into the heating chamber. It can be naturally occurring as the hot exhaust gases are buoyant, or mechanically assisted with fans.

Draft also refers to any current of air that exists in an enclosed area, such as a room. For instance, if there are cracks in the building envelope, a current of air will be felt as air enters or exits a building.

**Duct:** Ducts are used in distribution systems to deliver heated air. They can be made of metal, fiberglass or a material consisting of wire and plastic.

**Electrical Efficiency:** The electrical efficiency of a heating appliance refers to how much power it consumes to produce a given amount of heat. The amount of electricity an appliance will use depends on its design and configuration, and the efficiency of the motors and fans. It also depends on factors outside of the appliance, such as the efficiency of ducts in a forced air system.

Electrical efficiency is not factored into the AFUE of a combustion heater. It does not refer to how much heat an appliance will produce, but how much electricity it will use in producing and distributing that heat. A heating appliance that is more electrically efficient might use more efficient variable speed or electronically commutated motors (ECM) for fans and pumps. More electrically efficient devices will help reduce your electric bill.

**Electronically Commutated Motors (ECM):** See Variable Speed Motor

**Energy Factor (EF):** The EF is used to measure the overall unit efficiency of a water heater. It is based on the amount of hot water produced per unit of fuel consumed over a typical day. It already includes inefficiencies like standby losses, on/off cycling, and recovery times. The higher the EF, the more efficient the water heater is. The energy factor can be given as a percentage or a decimal (the maximum EF is 1, or 100%). For instance, a water heater might have an energy factor of 0.86, which corresponds to a percentage of 86%.

However, it is important to keep in mind that more efficient water heaters do not always mean lower operating costs, because the cost will also depend on the fuel used to heat the water, the size of the water heater and the water heater's first hour rating (the amount of hot water in gallons the heater can supply per hour, assuming that it starts with a full tank of hot water).



**Energy Star:** Energy Star is a program of the United States Department of Energy (DOE) and the Environmental Protection Agency (EPA). The goal of the program is to help Americans save money and protect the environment through energy efficient products and practices. Appliances that have earned the Energy Star label have met energy efficiency guidelines set by the EPA and DOE.

**Exhaust:** Exhaust refers to gases that result from combustion. Typically exhaust contains mostly nitrogen and carbon dioxide, although proportions will depend on the type of fuel burned. Exhaust also contains a small proportion of toxic gases and should be vented outside. Incomplete combustion will result in higher concentrations of toxic gases such as carbon monoxide (CO).

**First Hour Rating (FHR):** The FHR is the amount of hot water in gallons a storage water heater can supply per hour, assuming that it starts with a full tank of hot water. The FHR is determined by the size of the water tank, the source of heat and the size of the burner or element. It is used to properly size a storage water heater.

The FHR should be within a few gallons of a building's peak hourly demand. For a household with 3 occupants that routinely showers in the evening while running a dishwasher, the peak hourly demand might be around 45 gallons. This house would then need a domestic hot water (DHW) heater with a FHR of 40-50 gallons. You can calculate your peak hourly demand at the Energy Saver's website on hot water heaters: <http://1.usa.gov/pLDv5V>.

**Flue:** The flue is the pipe or passage that the combustion gases from a heating appliance travel through. It is also referred to as the stack or the exhaust.

**Flywheel Effect:** The flywheel effect can occur with masonry heaters, radiant floors, or passive solar design. It refers to the time it takes to raise the temperature of a large thermal mass, such as a radiant floor. The thermal mass then slowly releases its heat to the room as it cools. If a thermostat calls for heat, it may cause the boiler or other heating appliance to work for hours warming the slab to warm the room up to the desired temperature.

However, the excess stored heat in the slab will then continue to heat the room and lead to overheating. A sophisticated control system with temperature sensors in the slab and outside is needed to stop the supply of heat in time to prevent the room from overheating later.

**Forced Air:** Forced air heating systems use ducts to deliver heated air to rooms in a house. The heated air is provided by a heating appliance such as a furnace.

**Furnace:** A furnace is a heating appliance that produces heated air. It can use electricity to provide this heat, or combustion from natural gas, fuel oil, or wood.

**Grille:** A grille, or register, is a vent through which hot air from a forced air distribution system is delivered to a room or returned to the heating appliance. Technically, registers contain dampers and grilles do not, but the terms are often used interchangeably.

**Ground Source Heat Pump (GSHP):** A ground source heat pump is a heating appliance that uses electricity to “step up” geothermal heat to a temperature that can be used for distribution to a building.

**Heat Emitter:** Heat emitters are used to deliver heat from a heating appliance. For instance, radiators and baseboards are heat emitters that are used to deliver heat from hydronic systems into the rooms in a house.

**Heat Exchanger:** A heat exchanger is used in heating appliances to efficiently transfer heat from one medium to another. For instance, a heat exchanger may consist of a smaller pipe encased in a larger pipe. As a fluid flows through the smaller pipe, it can gain heat from warmer fluid in the larger pipe.

**Heating Degree Days (HDD):** HDD is the number of degrees Fahrenheit that the average temperature for a 24-hour day falls below 65°F. The reason 65°F is chosen is because typically, if the outdoor temperature is below 65°F, buildings will need additional heat. Each degree of mean temperature below 65°F is counted as 1 HDD.

For instance, if on December 1, the average temperature is 10°F, then December 1 has 55 HDD. To calculate this, first you subtract the average temperature of December 1 (10°F) from 65°F:

$$65^{\circ} F - 10^{\circ} F = 55^{\circ} F$$

Then, to find HDD, multiply by 1 day. The one day is because we are calculating the HDD for December 1, which is one day of the year.

$$HDD = 55^{\circ} F \times 1 \text{ day} = 55 \text{ HDD}$$

On December 1 in a different location, the average temperature might be 5°F. In that location, December 1 would have 60 HDD.

The annual HDD for a given location can be used to size heating systems and determine climate zones. It is calculated by adding up the HDD for each day of the heating season. Average annual HDD for some Alaskan locations are below (Alaska Climate Research Center, 2010):

Anchorage: 10,470  
Barrow: 19,674  
Fairbanks: 13,980  
Juneau: 8,574

**Heating Load:** The heating load is the amount of heat that a house requires. Usually, the heating load is reported as the maximum heat need needed per hour. For instance, a well-insulated 2-story house in Fairbanks might have a maximum heating load of 60,000 BTU/hr. The heating load for a building depends on the climate where the house is located, heat losses through the thermal envelope of the building, and the heat required for ventilation air (for mechanical ventilation systems and unregulated infiltration through cracks and openings in the house). While the heating load can be estimated by rule-of-thumb methods, it should be calculated using ACCA Manual J methods or AKWarm software.

**Heating Seasonal Performance Factor (HSPF):** The heat pump industry uses HSPF to rate a heat pump's overall efficiency over a heating season. It is a ratio of heat produced over a heating season to the electrical power consumed over the same heating season.

While COP is an instantaneous measure of heat pump efficiency, the HSPF attempts to take into account the reductions in efficiency caused by temperature fluctuations, supplemental heat, fans, and on/off cycling. A higher HSPF indicates a more efficient heat pump.

**HVAC:** HVAC refers to the Heating, Ventilation and Air Conditioning industry and products.

**Hydronic:** Hydronic refers to heating appliance and distribution systems that provide heat to a conditioned space in the form of hot water. For instance, a boiler and radiant floor is a hydronic system because the boiler produces hot water which is circulated through the radiant floor.

**Idle Losses:** Idle losses refer to the energy that is lost when an appliance operates at low capacity, or when the appliance is on but not producing heat. For instance, think of a car sitting at a red light. The engine is "on" and using gasoline but the car isn't moving. This situation results in "idle loss." Large heating appliances designed to heat an entire home that turn on to provide heat for only one room will experience idle loss.

**Integrated System:** An integrated system is a heating system that uses one appliance to provide heat for both space heating and domestic hot water. An integrated system is also called a combined system.

**Kilowatt-hour (kWh):** One kWh is equivalent to the amount of energy needed to expend one kilowatt of power for one hour. Electricity is sold by the kilowatt-hour.

For example, consider a 100 Watt, or 0.1 kW, light bulb that is turned on for 2 hours. It will have used 0.2 kWh (0.1 kW × 2 hours) of electricity.

**Latent Heat:** Latent heat is the heat absorbed or released by a substance during a change of state. There are two types of latent heat: the latent heat of fusion and the latent heat of vaporization. Each substance has a unique latent heat of fusion and a unique latent heat of vaporization.

Latent heat of fusion refers to the heat released when a substance freezes, or the heat absorbed when a substance melts. For example, snow requires an amount of heat energy (called its latent heat of fusion) to melt.

Latent heat of vaporization refers to the heat released when a substance condenses from a gas to a liquid, or the heat absorbed when a liquid vaporizes into a gas. In a boiler, when water vapor in exhaust condenses in the flue, it releases its latent heat of vaporization.

**Masonry Heater:** A masonry heater is a heating appliance that uses a large thermal mass to distribute heat from a hot, shortly-burning fire.

**Mechanically-drafted:** Mechanically-drafted combustion heating appliances use forced draft (a fan in front of the flame forces air into combustion chamber) or induced draft (a fan after the flame forcing exhaust gas up the vent) to vent gases away from the combustion chamber.

**Modulate:** To adjust, regulate or change. For instance, a modulating aquastat adjusts water temperature to be based on outdoor temperature. Some motors can also modulate their speed to match demand, which helps to save energy.

**Modulating Aquastat:** Aquastats control water temperature in boilers and other hydronic heating systems. They are usually set to have a high limit temperature and a low limit temperature. If the heating appliance causes the water to reach the high limit temperature, they will shut off the heating appliance. Also, if water reaches the low limit temperature, they will cause the heating appliance to fire to raise the water temperature. A modulating aquastat will vary the temperature that the water is heated to based on the outdoor temperature to save energy during the shoulder seasons of fall and spring. A modulating aquastat is also referred to as an outdoor reset.

**Naturally-drafted:** Naturally-drafted combustion heating appliances use the buoyancy of hot air to vent exhaust gases away from the combustion chamber. They do not operate safely in negative pressure conditions because such conditions will result in a backdraft.

**Outdoor Reset:** See modulating aquastat.

**Passive Solar System:** Passive solar systems use building design to collect, store, and distribute solar energy during the winter and reject excess solar heat in the summer.

**Peak Hourly Demand:** Peak hourly demand refers to the maximum need for space heating or hot water.

For space heating, the peak hourly demand occurs during the coldest day of the year. A heating appliance must be sized to adequately meet the house's need for space heating on this day. If the heating appliance is sized correctly, it will run almost continuously during the peak hourly demand time.

For hot water, the peak hourly demand occurs during the time of day that the household is using the most hot water. The hot water heater must be sized to be able to provide adequate hot water during the time of the peak hourly demand. You can estimate your peak hourly demand for hot water using the worksheet located on the Department of Energy's Energy Savers website: <http://1.usa.gov/pLDv5V>.

**Programmable Thermostat:** Programmable thermostats allow users to program a thermostat to change the set temperature of a heating system at certain times each day. For instance, instead of using a regular thermostat to keep the temperature at 68°F all the time, a family might use a programmable thermostat to set back the temperature to 60°F when they are asleep or at work. Using a programmable thermostat in this manner can save energy.

**R-value:** R-value measures how well a material resists heat flow. A higher R-value indicates a material with greater insulating properties. For example, a 2×6 wall with fiberglass insulation might have an R-value of 19. A double-paned window, on the other hand, has an R-value of around 2.

**Radiant Floor:** A radiant floor is one type of distribution system for a hydronic heating appliance. Hot water is pumped through pipes laid into or underneath a floor. The heated floor radiates heat throughout the room.

**Radiation:** Radiation is one of the three methods of heat transfer (see also Conduction and Convection). It is the method by which heat from the sun reaches the Earth through the vacuum of space. Heat travels by radiation when an object emits electromagnetic waves. The electromagnetic waves carry heat energy away from the emitting object, and can be absorbed by other objects. A campfire emits heat in the form of electromagnetic radiation. This heat can be absorbed by your hands if you hold them out towards the fire.

**Radiator:** A radiator is a heat emitter. It has pipes for hot water or steam that are arranged in an upright metal structure. As the name implies, as the metal heats up, it radiates heat to the room in the same way that a hot wood stove radiates heat to a room.

**Recirculating Hot Water System:** Recirculation hot water systems use a pump to continuously circulate hot water through pipes, so that there is instant hot water when a hot water faucet is turned on. While this system does require energy to run the circulation pump and also has heat loss through pipes while hot water is circulating, it can also save energy in houses where hot water faucets are located far from a hot water heater. In these houses, residents tend to open a faucet well in advance of needing hot water, which results in a large amount of cold water being wasted down the drain while the resident waits for hot water to arrive. These systems can be set up with timers that only recirculate hot water when it might be needed, or they can include a control, such as a button, that allows a resident to turn on the recirculation feature when they need it.

**Register:** A register, or grille, is a vent through which hot air from a forced air distribution system is delivered to a room or returned to the heating appliance. Technically, registers contain dampers, and grilles do not, but the terms are often used interchangeably.

**Sealed Combustion:** In sealed combustion heating appliances, the combustion process takes place in a chamber that is closed off from the air inside the building. The chamber is connected to the outside by a sealed pipe for combustion air, and a sealed flue vents exhaust gases. Appliances with sealed combustion chambers are safer because the combustion air and exhaust gases cannot enter the building interior.

**Setback:** Setback refers to when a temperature setting for a room or zone is lowered for a period of time (such as at night or when occupants are at work) to save energy.

**Solar Thermal System:** Solar thermal systems gather heat from the sun using collector panels. This heat is transferred to water in a storage tank by means of a circulating fluid. The heated water can be used for a domestic hot water system, or for a hydronic distribution system. Solar thermal systems are also called active solar systems.

**Solar Water Heater:** Solar water heaters collect heat from the sun using collector panels. They transfer this heat to a storage tank of domestic hot water to provide heated water to a house.

**Space Heaters:** Space heaters provide heated air which is distributed using a fan or by passive convection. They are meant to provide heat to a room or cabin, not an entire building, and do not require a separate distribution system. They can provide heat using combustion of fuel oil, natural gas or biomass or by using electricity.

**Stack:** In combustion appliances, the stack refers to flue that carries combustion gases away from the combustion chamber.

**Stack Effect:** Stack effect is the tendency of warmer, less dense air to rise, and cooler, denser air to fall. In a building, the stack effect results in an upward movement of air. This causes low pressure in the building's lower levels which can draw in moisture and gases into the building near the foundation. It also results in positive pressure in the upper levels of the building, which can push warm, moist air through cracks and gaps in the upper walls and ceilings.

**Stack Losses:** Stack losses occur in combustion heating appliances. They refer to the heat that travels up the stack (out the flue or chimney) without contributing to space heating.

**Standby Losses:** Standby losses occur in conventional storage water heaters. Standby loss is the heat lost through the hot water storage tank surface. As the hot water sits in the tank, heat is lost through the insulated walls of the tank. A well-insulated tank will have less standby loss than a poorly insulated tank.

Heating appliances such as furnaces and boilers also have standby losses. The standby loss for a furnace or boiler is the heat lost from the appliance surface (as opposed to the heat lost up the chimney).

**Steady State Efficiency (SSE):** SSE refers to the efficiency of a boiler or furnace while it is running at full load. It measures how effectively the appliance uses the heat from combustion once the appliance has warmed up. The rated SSE will always be higher than the rated AFUE; however both ratings depend on the installation and operating conditions.

As both boilers and furnaces lose efficiency when they cycle on and off, the AFUE is more indicative of the efficiency that will be delivered to a building. You can think of SSE as like the miles per gallon that a car gets cruising on the highway, while AFUE can be compared to miles per gallon obtained driving the same car in stop and go traffic.

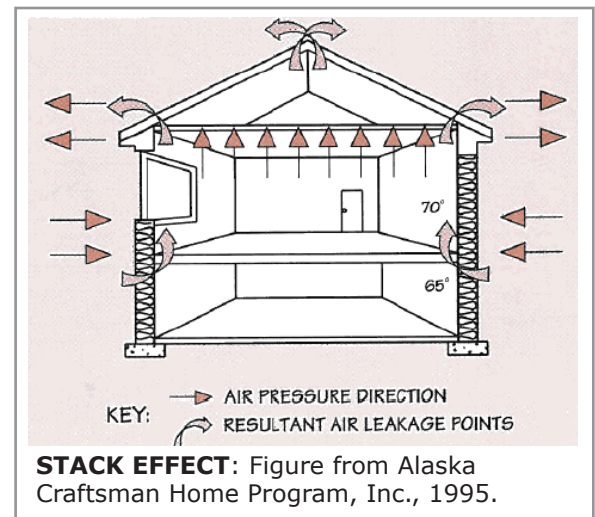

**Storage Water Heater:** Storage water heaters heat water that is kept in an insulated storage tank. The water can be heated using combustion (burning natural gas, propane, fuel oil or natural gas) or using electricity. While storage water heaters do offer a ready supply of heated water at all times, they do lose energy to standby losses.

**Stove:** A stove is a heating appliance that has a firebox for the combustion of wood, pellets or coal. The heat from the fire warms the stove, which then radiates the heat throughout a room.

**System Efficiency:** System efficiency is the combined efficiency of the heating appliance, distribution system and domestic hot water (DHW) system if it is combined with the heating system. An approximation of this efficiency can be found by multiplying the efficiencies of each system component. For instance, if a home has a 78% efficient oil-fired furnace, and a 75% efficient duct distribution system, and no DHW system, then the total efficiency will be 59%.

$$\text{Total Efficiency} = \text{Heating Appliance Efficiency} \times \text{Distribution Efficiency}$$

$$\text{Total Efficiency} = 0.78 \times 0.75 = 0.585 \sim 59\%$$

However, the system efficiency is slightly more complicated than this, as it is also affected by the system controls. Control components such as time-delay components, zoning and programmable thermostats can save fuel and help a system reach its efficiency potential.

More efficient appliances contribute to higher system efficiency, as do controls that allow the system components to work together. It is important to discuss both system efficiency and appliance efficiency with a heating contractor.

**Tankless Domestic Hot Water Heater:** Tankless domestic hot water heaters heat water as needed. When a faucet calls for hot water, cold water travels through the tankless unit. The water is heated as it flows through the tankless heater, which can use natural gas, propane or electricity to provide heat.

**Therm:** One therm is equal to 100 cubic feet of natural gas. A therm is also a unit of heat energy. One therm is equal to 100,000 BTUs. This is approximately the heat energy of burning 100 cubic feet of natural gas. However, the actual BTU content of a therm of natural gas can vary because the make-up of natural gas depends on its origin.

**Thermal Envelope:** The thermal envelope of a building separates the heated interior from unconditioned space (such as an unheated attic) or the outside. It consists of the foundation, walls, doors, windows and roof assembly, insulation and vapor retarders. In some places it is the same as the building envelope but may differ if the main thermal insulation is in the attic floor, and the building's actual roof is located well above that.

**Thermostat:** Thermostats regulate the temperature of a room or zone in a building. Residents can input a set temperature into a thermostat. If the room temperature falls below the set temperature, the thermostat calls for a heating appliance to be turned on. When the temperature has risen to the desired level, the thermostat signals for the heating appliance to turn off.

**Time-delay Relay:** Time-delay relays are the control component in a system with a buffer tank. When a thermostat calls for heat, a time-delay relay determines if the water in the buffer tank is hot enough to provide sufficient heat or if the heating appliance needs to turn on to raise the temperature of the water temperature. Time-delay relays save energy because they help heating appliances avoid on/off cycling when a small amount of heat is called for.

**Ton (weight):** One ton is equal to 2000 pounds. Coal is often sold by the ton.

**Ton (heating capacity):** A ton is a HVAC term that measures heating or cooling capacity. The term comes from the air conditioning industry: One ton of cooling capacity is defined as the amount of cooling that would be provided by melting one ton of ice. One ton of heating or cooling capacity is equal to 12,000 BTUs.

**Trombe Wall:** A trombe wall is sometimes used in passive solar design. It is an 8 to 16 inch thick masonry wall on the south side of a building. It absorbs heat from solar radiation, which is conducted through the wall's mass and radiates into the living space over the course of several hours.

**Variable Speed Motor:** A variable speed motor can run at continually-varying speeds to match its output to the load. Variable speed motors, also known as electronically commutated motors (ECM) are becoming more common in air handling units and heating appliance blowers. These motors are more efficient because they operate at full capacity only when needed. By operating at lower speeds when full speed is not required they can save a surprising amount of energy as the power they use is proportional to the cube of the motor speed. For example, reducing the speed by a factor of 2 reduces the power used by a factor of 8!

**Zoning:** Zoning is a control strategy that divides a building into sections. It allows a heating system to maintain different temperatures in different areas. Each area, or zone, has its own thermostat and distribution loop. Zoning is an energy-saving strategy because it allows residents to decrease the heat in areas where it is not needed all the time, such as a guest room.